

Mobile Communication Chapter 1-1

Digital Communications

참고문헌

**Digital communications Fundamentals and
Applications by SKLAR**

Digital Communication System Block diagram

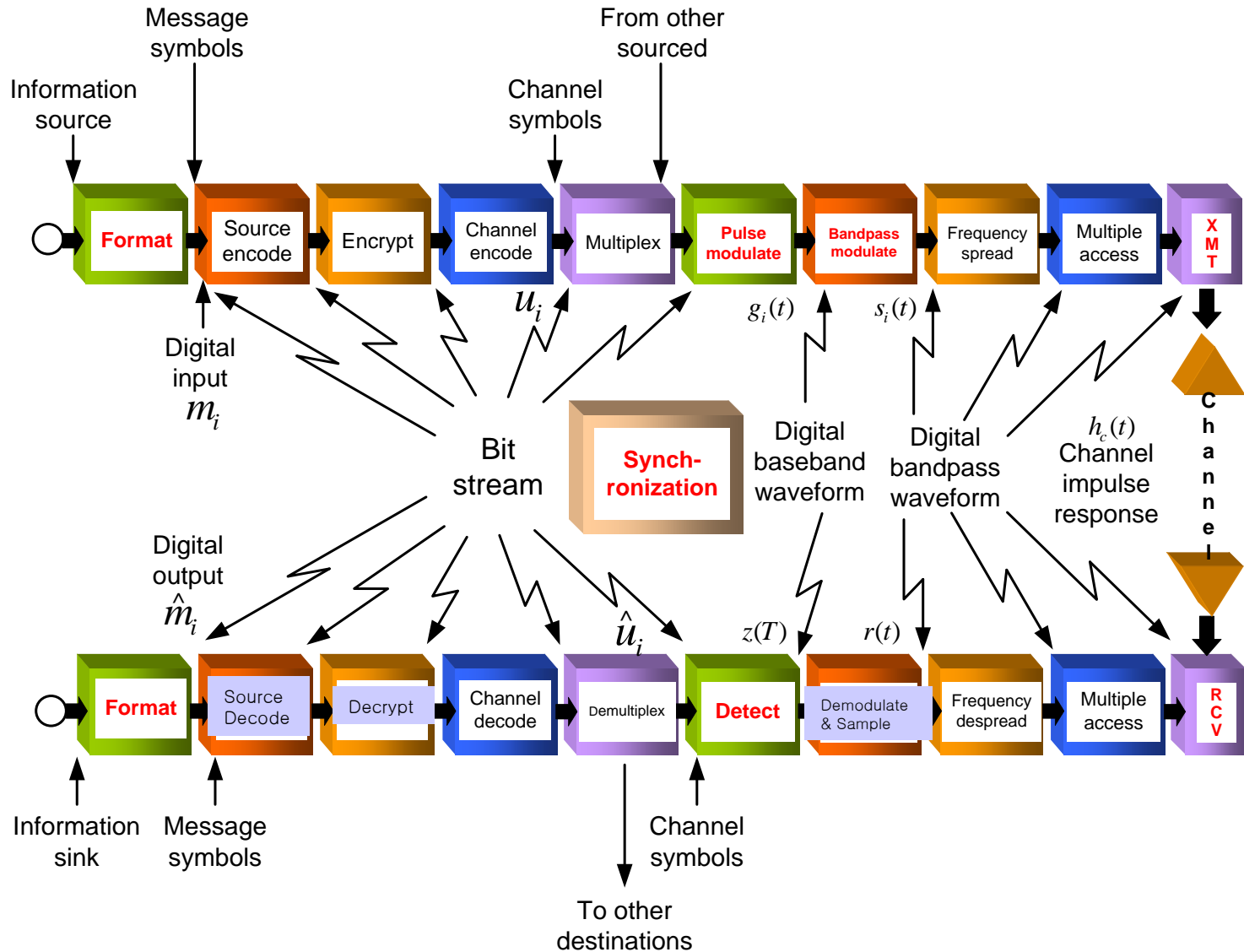

◆ Why Digital?

- A. Easy to regenerate original function
- Signal distorted by non-ideal transfer function in all transmission & circuits.
 - Unwanted electrical noise & other interference distorts.

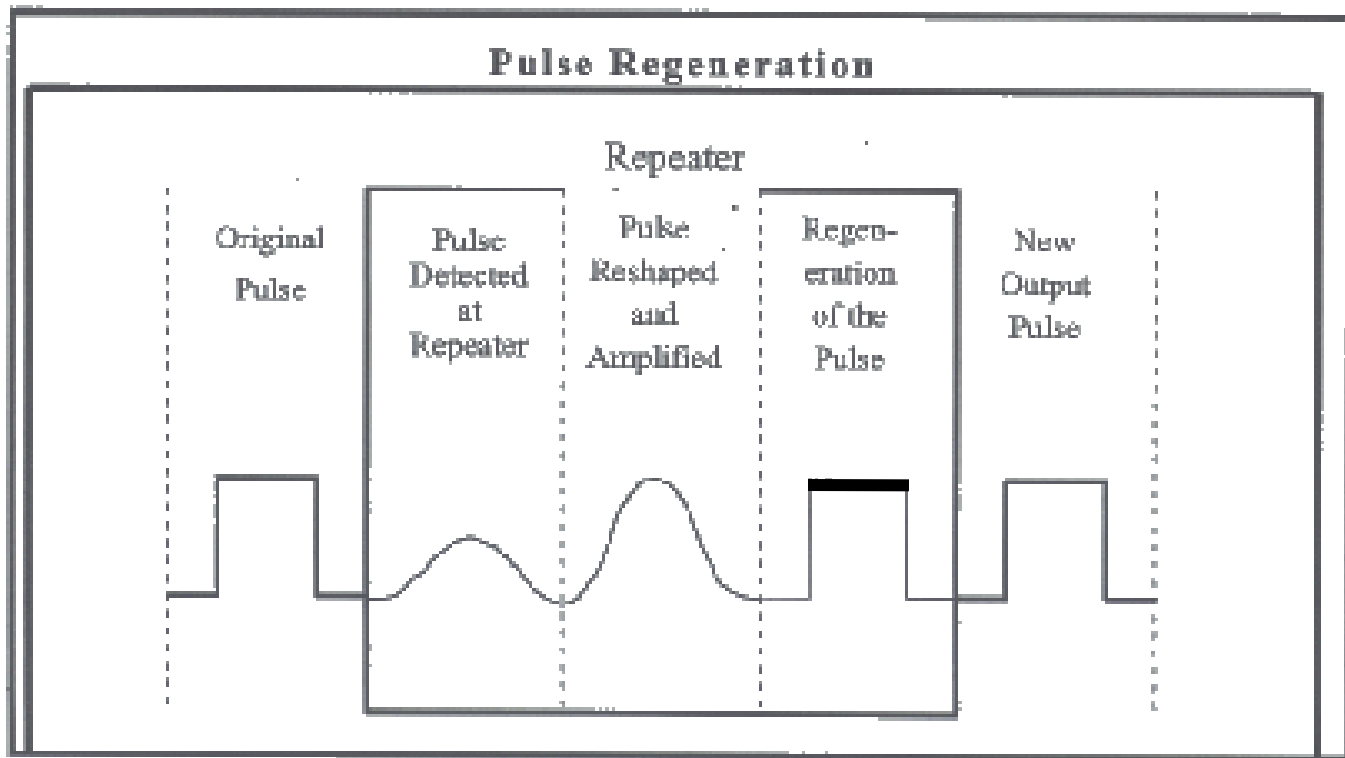

Why Digital? (Cont.)

- B. High signal fidelity can be obtained with extremely low error rates through Digital techniques s.a. error detection & correction coding.
- C. Digital circuits are more reliable, lower cost, more flexible implementation in H/W(Micro-processor, LSI, Digital switch etc...)
- D. Easy to multiplex various types of signal \Rightarrow Multimedia service
- E. It is against interference & Jamming (Encryption)

◆ Disadvantages

- A. More technical complexity
- B. Required additional steps
 - Sampling & A/D conversion
- C. Required complicated synchronization issues
 - Frame sync.
 - Carrier Recovery sync.
 - Symbol timing recovery sync.
 - Network sync.
- D. Non-graceful degradation
 - Sudden quality changes at SNR threshold

Digital Communication System

Basic Signal Processing

Formatting

Character coding
Sampling
Quantization
Pulse code modulation (PCM)

Source Coding

Predictive coding
Block coding
Variable length coding
Synthesis/analysis coding
Lossless compression
Lossy compression

Baseband Signaling

PCM waveforms (line codes)
Nonreturn-to-zero (NRZ)
Return-to-zero (RZ)
Phase encoded
Multilevel binary
M-ary pulse modulation
PAM, PPM, PDM

Equalization

Maximum-likelihood sequence estimation (MLSE)
Equalization with filters
Transversal or decision feedback
Preset or Adaptive
Symbol spaced or fractionally spaced

Bandpass Signaling

Coherent

Phase shift keying (PSK)
Frequency shift keying (FSK)
Amplitude shift keying (ASK)
Continuous phase modulation (CPM)
Hybrids

Noncoherent

Differential phase shift keying (DPSK)
Frequency shift keying (FSK)
Amplitude shift keying (ASK)
Continuous phase modulation (CPM)
Hybrids

Channel Coding

Waveform

M-ary signaling
Antipodal
Orthogonal
Trellis-coded modulation

Structured Sequences

Block
Convolutional
Turbo

Synchronization

Frequency synchronization
Phase synchronization
Symbol synchronization
Frame synchronization
Network synchronization

Multiplexing/Multiple Access

Frequency division (FDM/FDMA)
Time division (TDM/TDMA)
Code division (CDM/CDMA)
Space division (SDMA)
Polarization division (PDMA)

Spreading

Direct sequencing (DS)
Frequency hopping (FH)
Time hopping (TH)
Hybrids

Encryption

Block
Data stream

Digital Communication System

Signal Processing Functions

- ✦ **Formatting** Transforms the source information into digital symbols by the sampling, quantization and coding.
- ✦ **Source coding** removes redundant or unneeded information
- ✦ **Encryption** prevents unauthorized users from understanding messages and from injecting false messages into the system.
- ✦ **Channel coding**, for a given data rate, can reduce the probability of error, or reduce the signal-to-noise ratio(SNR) requirement, at the expense of bandwidth or decoder complexity.
- ✦ **Modulation** is the process by which the symbols are converted to waveforms that are compatible with the transmission channel.
- ✦ **Frequency spreading** can produce a signal that is less vulnerable to interference and can be used to enhance the privacy of the communicators.
- ✦ **Multiplexing** and **Multiple Access** procedures combine signals that might have the different characteristics or might originate from different source, so that they can share a portion of the communications resources.

+ Binary digit(bit) : This is the fundamental information unit for all digital systems

+ Bit stream : This is a sequence of binary digitals (ones and zeros)

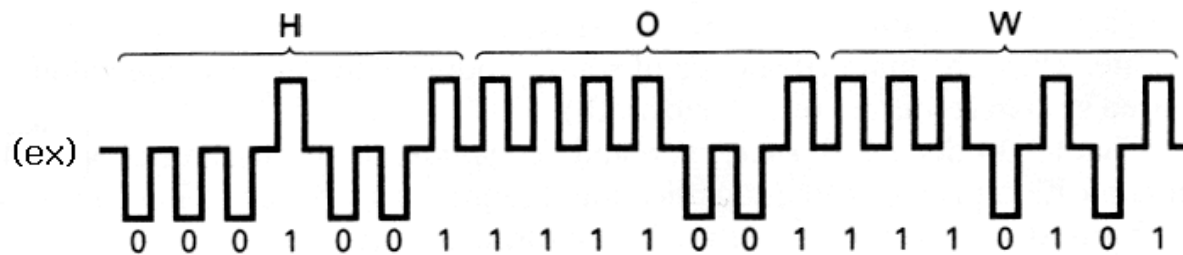

+ Symbol (digital message) : A symbol is a group of k bits

(ex) 1 Binary symbol ($k = 1, M = 2$)
 10 Quaternary symbol ($k = 2, M = 4$)
 011 8-ary symbol ($k = 3, M = 8$)

- ✚ Digital waveform : This is a Voltage or current waveform (a pulse for baseband transmission, or a sinusoid for bandpass transmission) that represents a digital symbol.

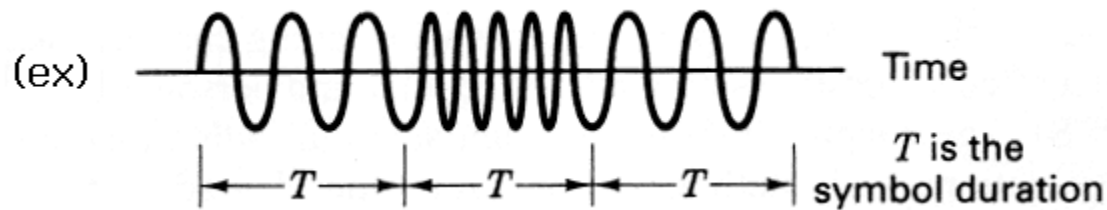

- ✚ Data rate : This quantity is bits/sec(bps)

(ex) $6\text{bits} / 6\text{ms} = 1000\text{bits/s}$

- ✚ Symbol rate (baud rate) : the rate at which the signal state changes when observed in communication channel

Ex) If a system uses four symbols to convey pairs of bits through a channel & the symbol is changed every 0.5ms

$$\text{symbol rate} = 1 / 0.5 \text{ ms}$$

$$= 2000 \text{ symbols/sec} = 2000 \text{ baud rate}$$

$$\text{data rate} = 2 / 0.5 \text{ ms} = 4000 \text{ bps}$$

+ Bandwidth efficiency \rightarrow bits/ sec/ Hz

Ex) If a system requires 4KHz of bandwidth to continuously send 8000 bps of information,

$$\text{Bandwidth efficiency} = 8000\text{bps} / 4000\text{Hz}$$

$$= 2\text{bits/sec/Hz}$$

Signal Transmission through the linear system



+ $x(t) \rightarrow h(t) \rightarrow y(t)$: Time domain

+ $X(f) \rightarrow H(f) \rightarrow Y(f)$: Frequency domain

+ Impulse Response : $y(t) = h(t) * \delta(t) = h(t)$

$$y(t) = h(t) * x(t) = \int_{-\infty}^{\infty} x(\tau) h(t - \tau) d\tau$$

+ Frequency transfer function : $x(t) * h(t) \xleftarrow{\text{F.T.}} X(f) \cdot H(f)$

$$Y(f) = X(f) \cdot H(f)$$

$$H(f) = \frac{Y(f)}{X(f)}$$

Digital Signal Processing

- + **Formatting** is the first *essential signal processing step* and transforms source information to digital symbol. The main formatting process is sampling, quantization, and coding.
- + Transmission through a base-band channel(pair of wires or a coaxial cable). For baseband channels, compatible waveforms are pulse.

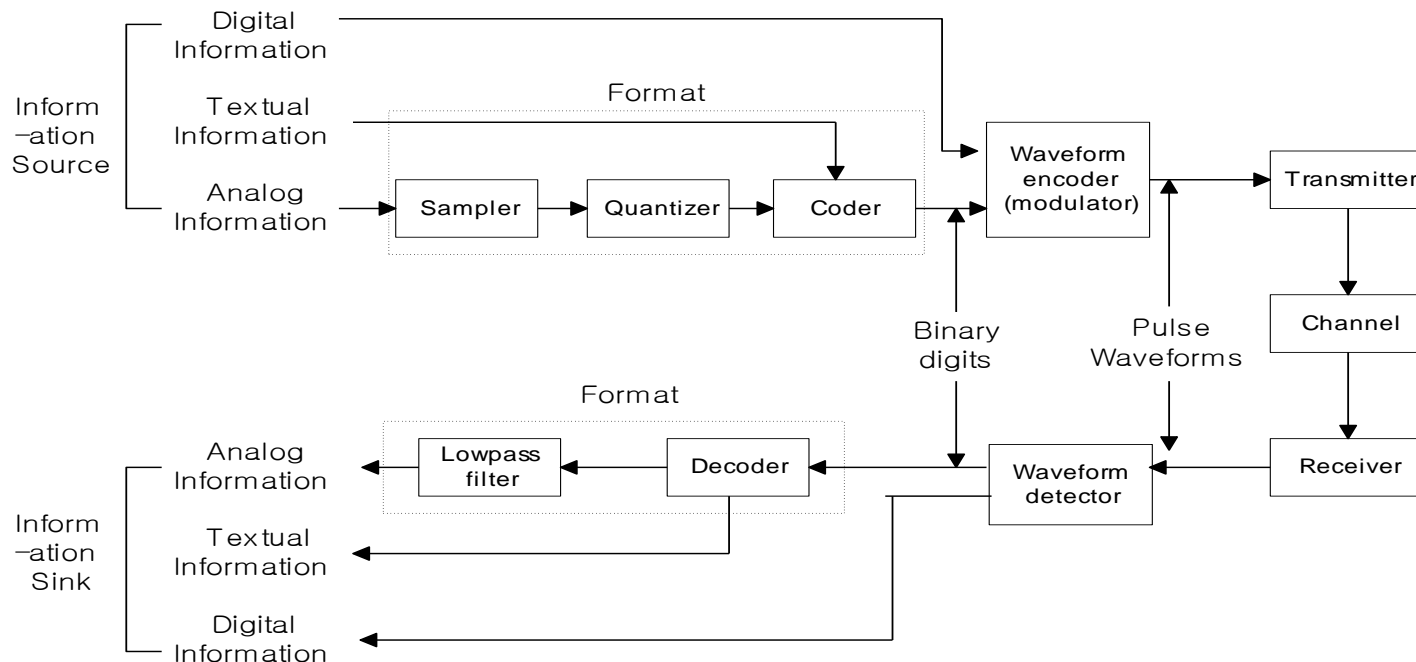

Formatting analogue information

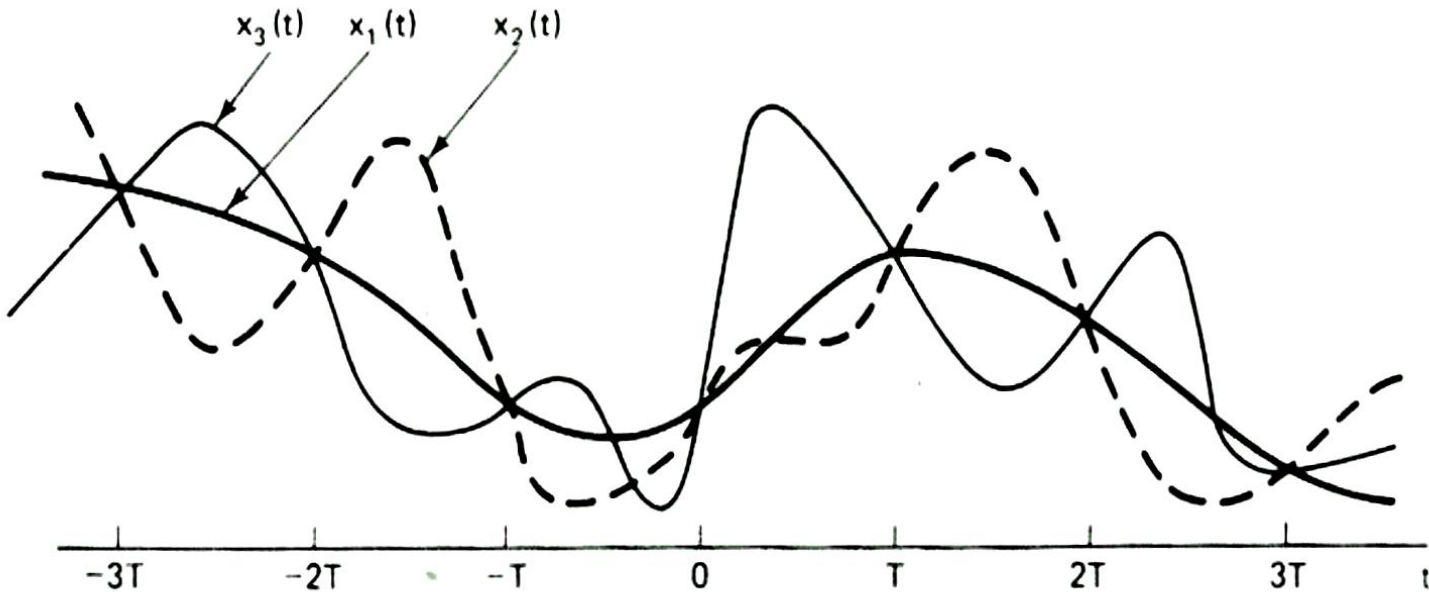
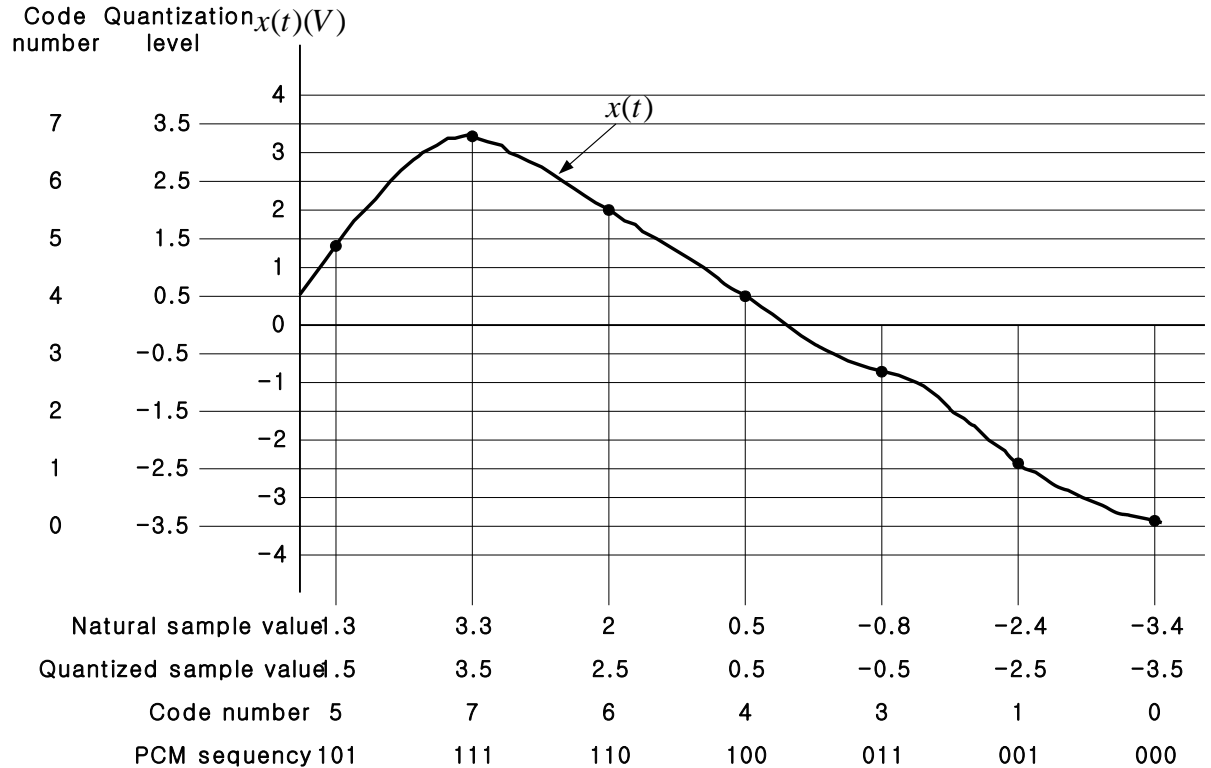

Figure 8.1 Three continuous-time signals with identical values at integer multiples of T .

Pulse Code Modulation



Formatting Analog Information
(Natural samples, quantized samples, pulse code modulation)

ex) 음성 대역폭 $f_m = 4\text{kHz}$, Quantization level \Rightarrow 256 level 일 때

PCM신호는 몇 kbps? $f_s = 4\text{K} \times 2 = 8\text{K}$, $256 = 2^8$, $8\text{K} \times 8 \text{ bits} = 64\text{kbps}$.

◆ Sampling Theorem (by Shannon, 1949)

정의: A band-limited signal having no spectral components above f_m Hz can be determined uniquely by values sampled at uniform intervals of T_s seconds, where

$$T_s \leq \frac{1}{2f_m} \quad \left(T_s = \text{Sampling time interval} \quad f_s = \frac{1}{T_s} \right)$$

Nyquist criterion $f_s \geq 2f_m \rightarrow$ *Nyquist rate*

-> 등 간격의 discrete time sample로부터 Analog 신호를 완벽하게 재생해 내기 위한 조건임

$$x_\delta(t) = \sum_{n=-\infty}^{\infty} \delta(t - nT_s), \quad x_s(t) = x(t) \cdot x_\delta(t) = \sum_{n=-\infty}^{\infty} x(t) \delta(t - nT_s) = \sum_{n=-\infty}^{\infty} x(nT_s) \delta(t - nT_s)$$

$$x_\delta(t) \xrightarrow{F.T.} X_\delta(f) = \frac{1}{T_s} \sum_{n=-\infty}^{\infty} \delta(f - nf_s)$$

$$\therefore X_s(f) = X(f) * X_\delta(f) = X(f) * \left[\frac{1}{T} \sum_{n=-\infty}^{\infty} \delta(f - nf_s) \right]$$

$$= \frac{1}{T} \sum_{n=-\infty}^{\infty} X(f - nf_s)$$

Sampling Theorem (Cont.)

Time Domain

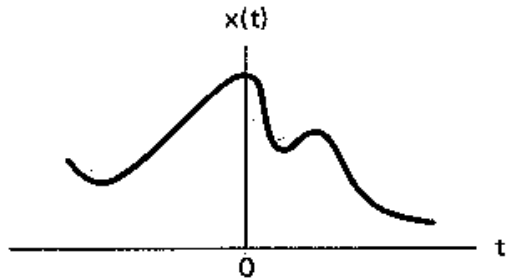

$\xrightarrow{F.T.}$

Frequency Domain

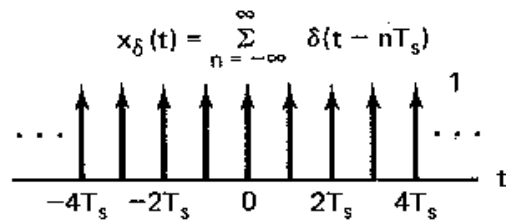
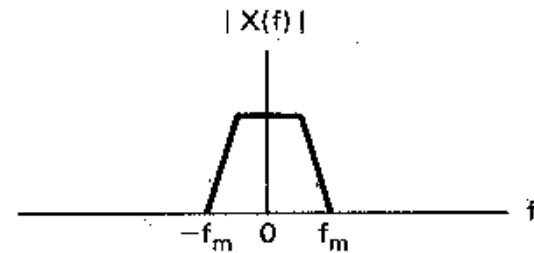

$\xrightarrow{F.T.}$

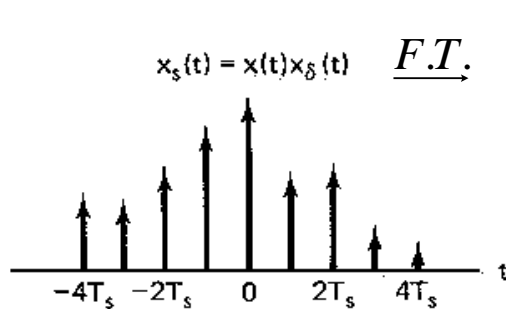
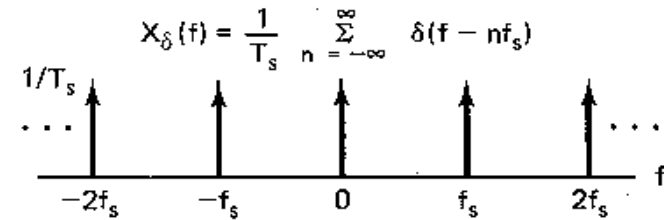

$\xrightarrow{F.T.}$

$$X_s(f) = \frac{1}{T} \sum_{n=-\infty}^{\infty} X(f - nf_s)$$

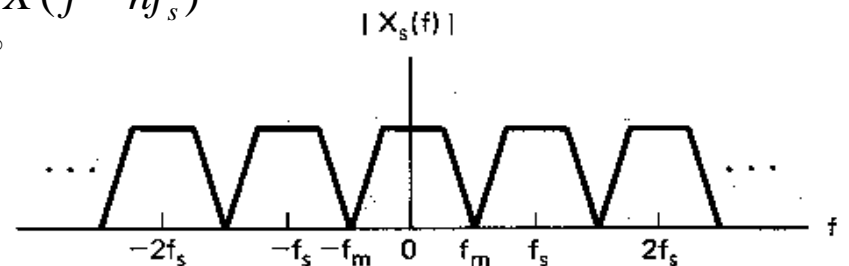

Spectra for various sampling rates

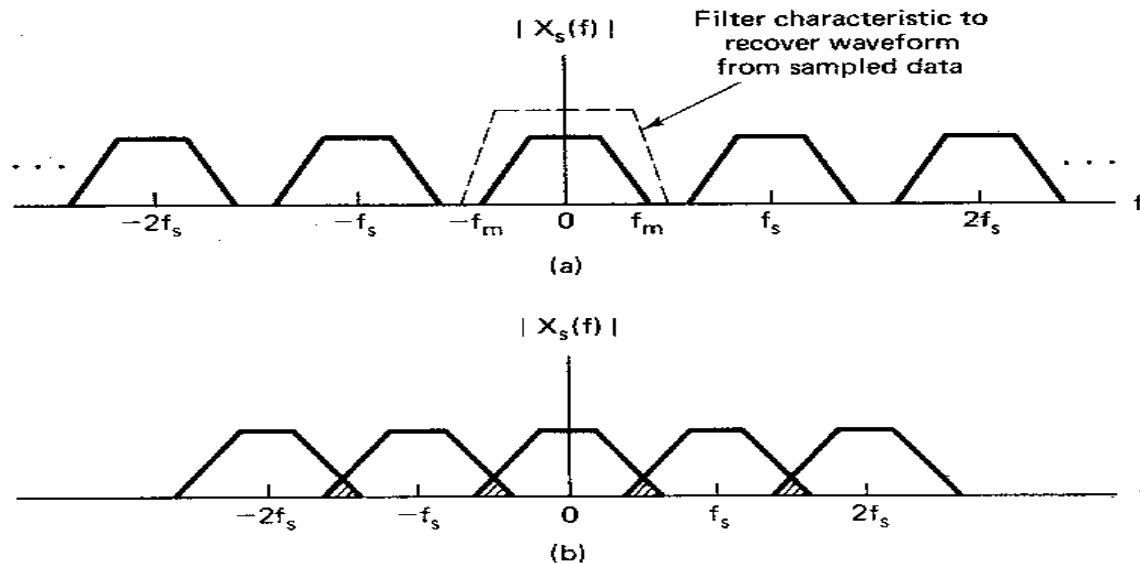

Figure Spectra for various sampling rates. (a) Sampled spectrum ($f_s > 2f_m$).
(b) Sampled spectrum ($f_s < 2f_m$).

Ex) Digitization of a 20kHz 6W music source.

1. $f_s \geq 40$ ksamples/s

2. Engineering's version : 44.0 ksamples/s

⇒ CD player : 44.1 ksamples/s /

⇒ Studio-quality audio 48.0 ksamples/s

Spectra for various sampling rates

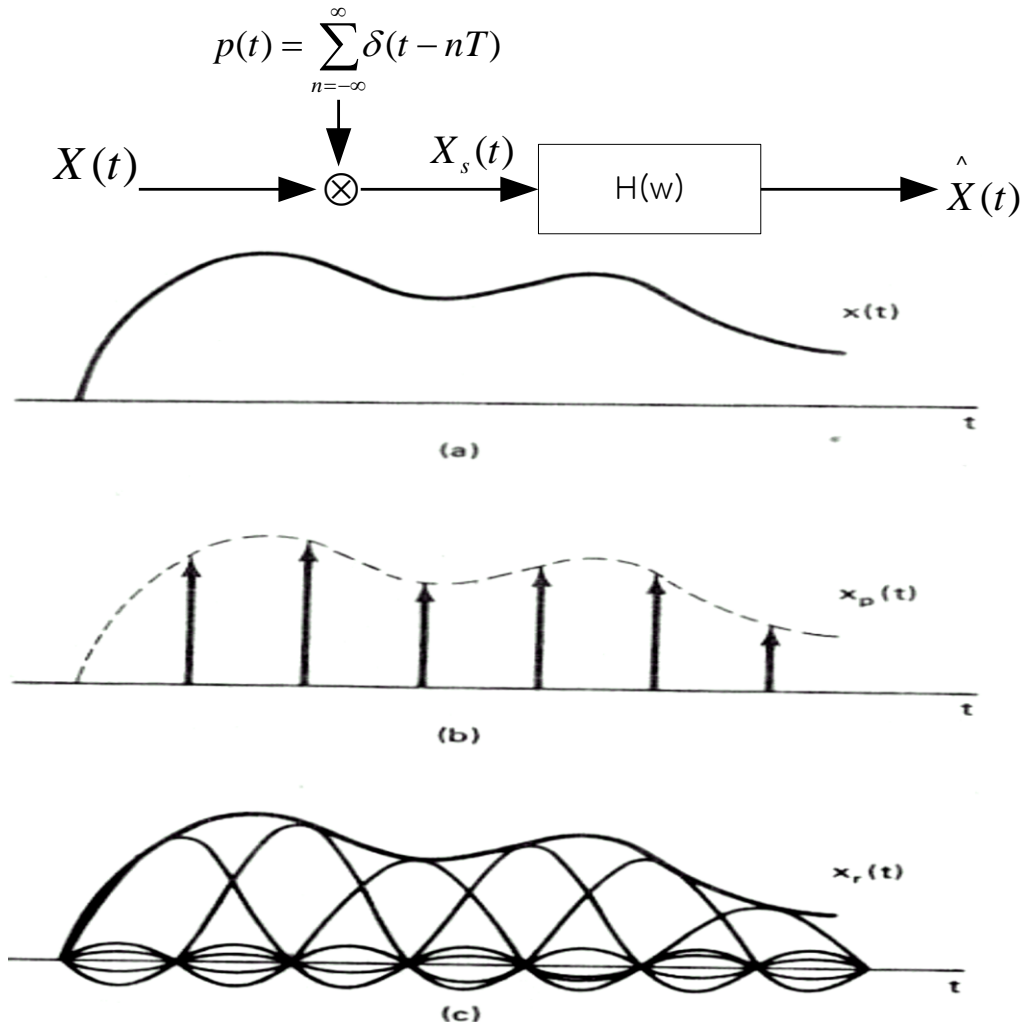

< Ideal band limited interpolation using the sinc function >

Three levels of coding

Three levels of coding

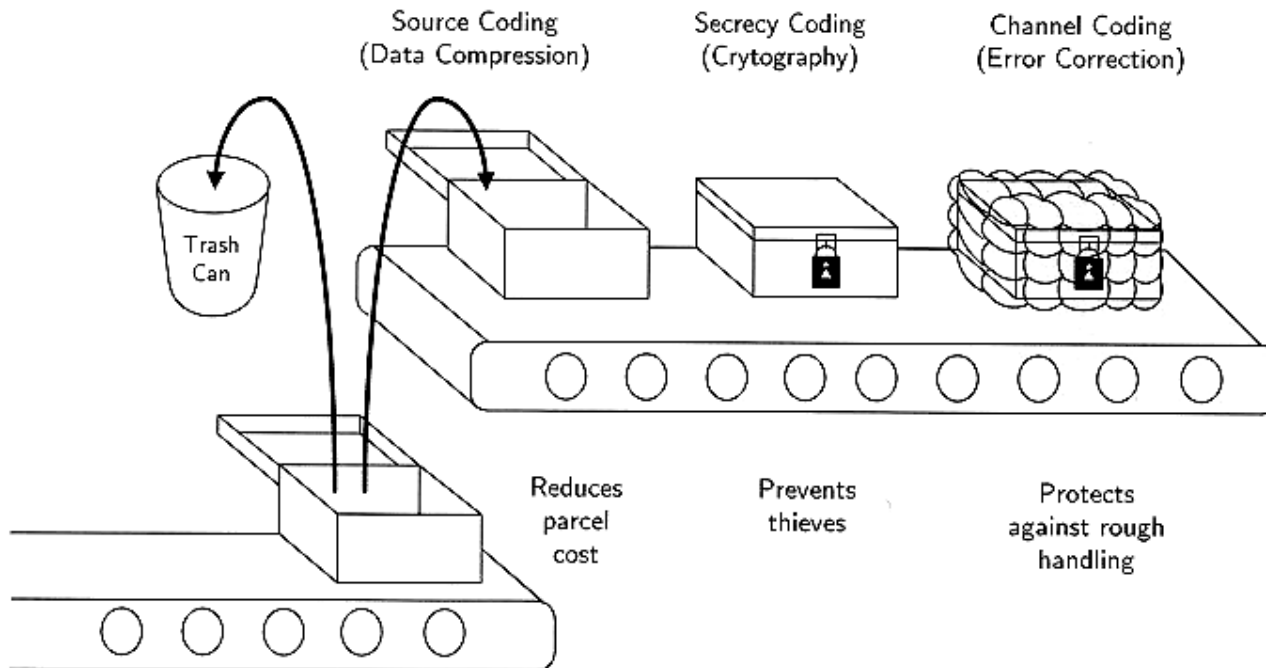

1. Source coding (data compression)

- ❑ Reduce the amount of redundancy in source information so that high information transmission rate can be achieved

2. Secret coding (cryptography)

- ❑ Disguise message to prevent unauthorized intercept

3. Channel coding (error correction)

- ❑ Minimizing the error rate in the received symbols when transmitting information over noisy channel

- Coding provides **increasing transmission Bandwidth and Complexity** but **high accuracy with less energy** than uncoded communications

Channel Coding

◆ Objectives of the Channel Coding

1. To Overcome The Limitations of the Communication System
2. To Ensure the Reliable Transmission

◆ Three Problems in Channel Coding

1. To Find a Good Codes
2. To Find a Decoding Algorithm for the Codes
3. To Find a Way of Implementing the Decoding Algorithm

◆ Channel Coding

1. Channel Error의 종류

- Burst Error
- Random Error

2. Channel Error Control 방법

- Muting : Error를 Detecting

(예 : 단방향 Paging 시스템)

- Automatic Retransmission Query : Error Detect 후 재전송요구

- Forward Error Correction : 수신단에서 Error Detection & Correction

(예 : 전송 Delay가 커서 재전송 요구가 어려운 위성통신시스템의 경우)

3. Terminal Connectivity 와 Error Control 관계

Terminal Connectivity와 Error Control

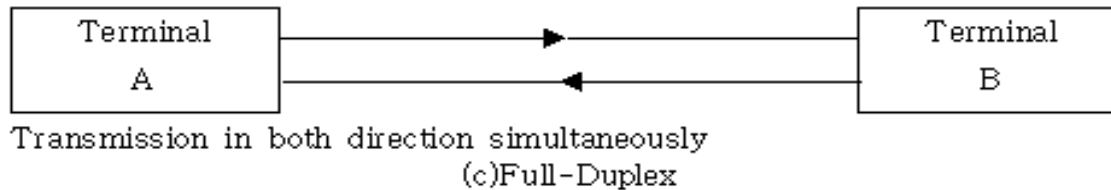
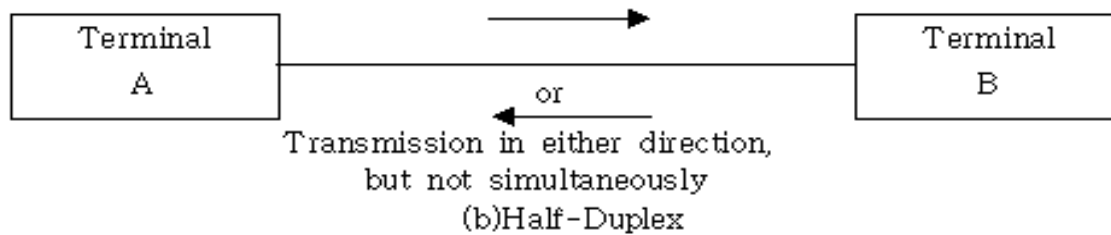
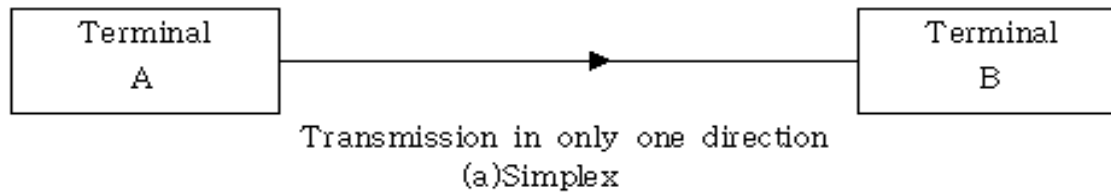

- ▷ Error Detection & ARQ 가능 : Half / Full Duplex 시스템
- ▷ Forward Error Correction : 모두 사용 가능
- ▷ ARQ 특징 :
 - a. Simplex 시스템 사용불가
 - b. 전송 Delay가 클 경우 사용불가
 - c. 재 전송요구 과대한 경우 Heavy Throughput Degradation 발생으로 사용불가

Channel Coding(cont.)

4. Forward Error Correction을 위한 Channel Coding 종류

- Block Code : Hamming Code, Hadamad Code, Gray Codes, Cyclic Code, Reed-Solomon Code
- Convolutional Code : Viterbi Algorithm, Fano's Sequential Decoding, The Stack Algorithm, Feedback Decoding

5. Channel Performance (또는 Communication System Performance)는

- Bandwidth
 - Signal Power
 - Noise Level 과 밀접한 관계
- ▷ In power Limited Application, Increase the Transmission Channel Bandwidth by Introducing Coding ⇒ Deep Space, CDMA Cellular 시스템
- ▷ In B. W. Limited Application, Increase the Transmission Power ⇒ Telephone Line

6. Code Rate and Redundancy

▷ k bits : Input Message length

n bits : Coded Output Message length

then, $(n-k)$ bits added \Rightarrow redundant information bits.

▷ 표현방법 : $[n, k]$

▷ Redundant of the Code $\Rightarrow \frac{n-k}{k}$

▷ Code Rate : $R_c = \frac{k}{n} = \frac{\text{number of input bits}}{\text{number of output bits}} < 1$

Ex) $1/2$ rate $\Rightarrow 1/2$ bits of Information, 100% Redundancy, Double B.W.

Ex) $3/4$ rate $\Rightarrow 33\%$ Redundancy, B.W. $\Rightarrow 4/3$ 배

◆ Convolutional Coding 특징

- ▷ Good for Random Error
- ▷ Good for AWGN Channel
- ▷ Good for Burst Error channel if interleaved
- ▷ Easy soft decision decoding
 - Extra coding gain
- ▷ Easy Multi-rate codec implementation
- ▷ Applications
 - (a) Satellite communication
 - VSAT, DBS(HDTV), MSAT, INMARSAT
 - (b) CEPT GSM system
 - (c) CTIA digital cellular system (IS-95, IMT-2000, etc.)
- ▷ Used for most radio communication system

✚ Coding in communication link

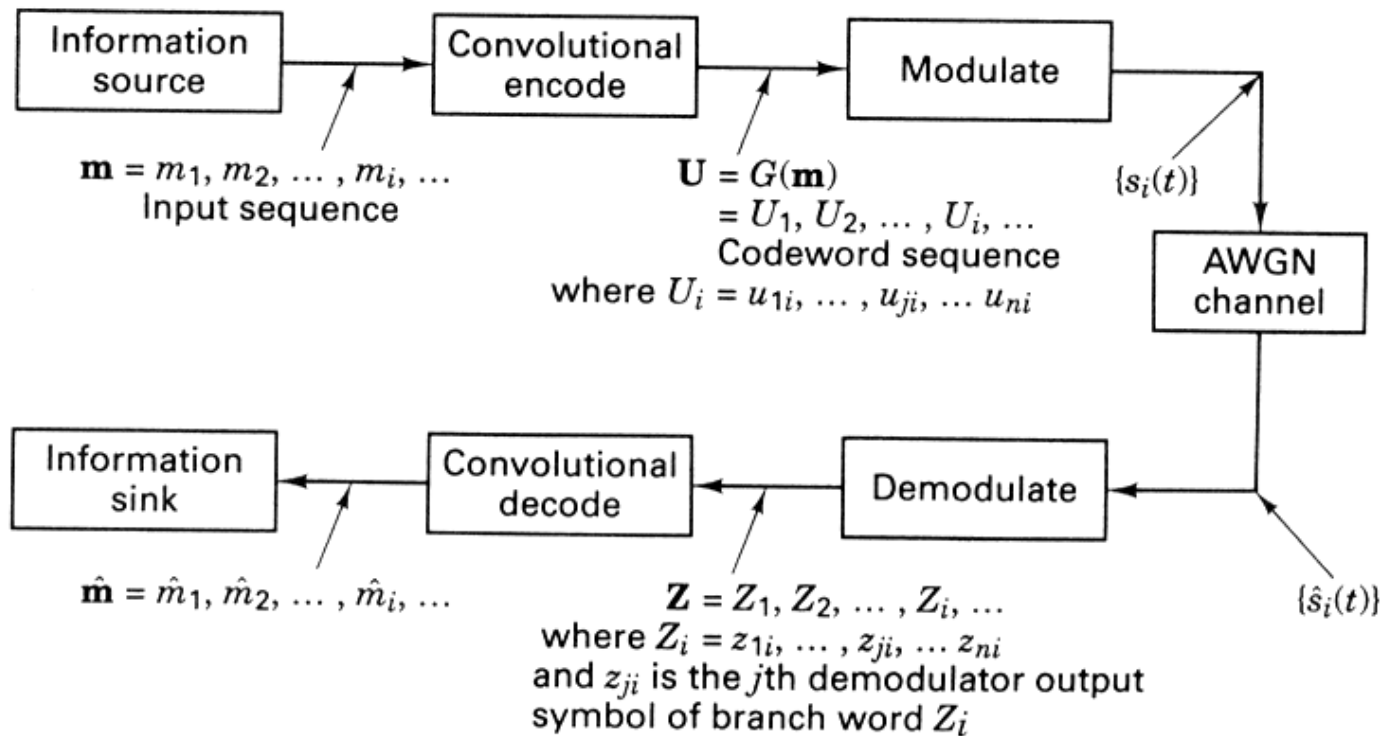

Channel Coding (cont.)

◆ [N,K] Convolutional Encoder

⇒ m개의 memory와 k개의 input과 n개의 output을 갖은 linear sequential circuit
실제의 경우 n=2, k=1인 [2,1] 즉, rate 1/2 convolutional code가 주로 사용됨
ex) m=3 인 경우

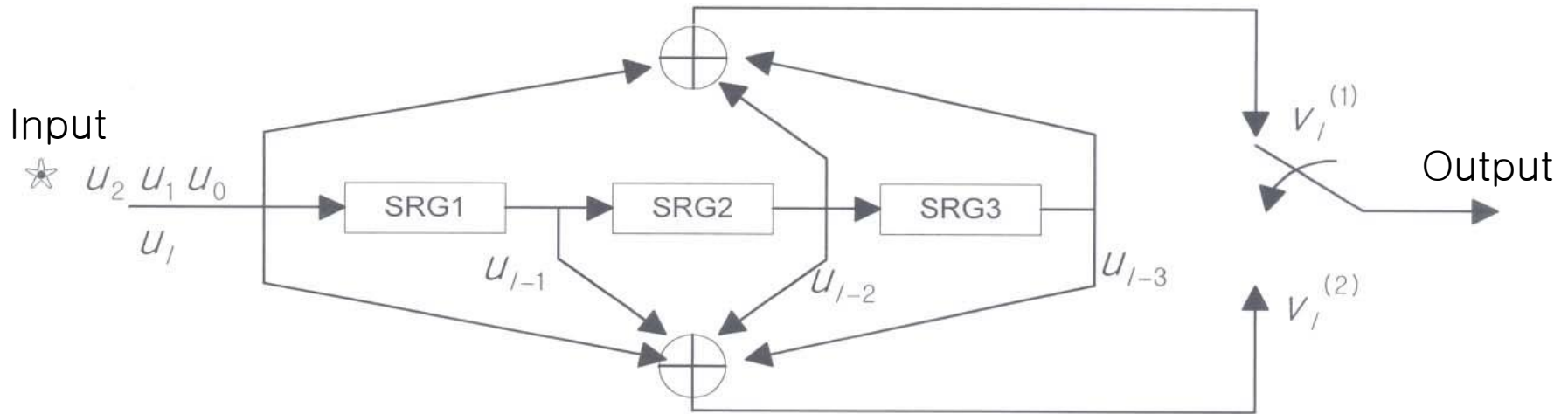

현재의 output ($V_I^{(1)}, V_I^{(2)}$)은 현재의 input U_I 과

과거의 m개의 input $U_{I-1}, U_{I-2}, \dots, U_{I-m}$ 에 의해서 결정된다.

Digital Signal Processing

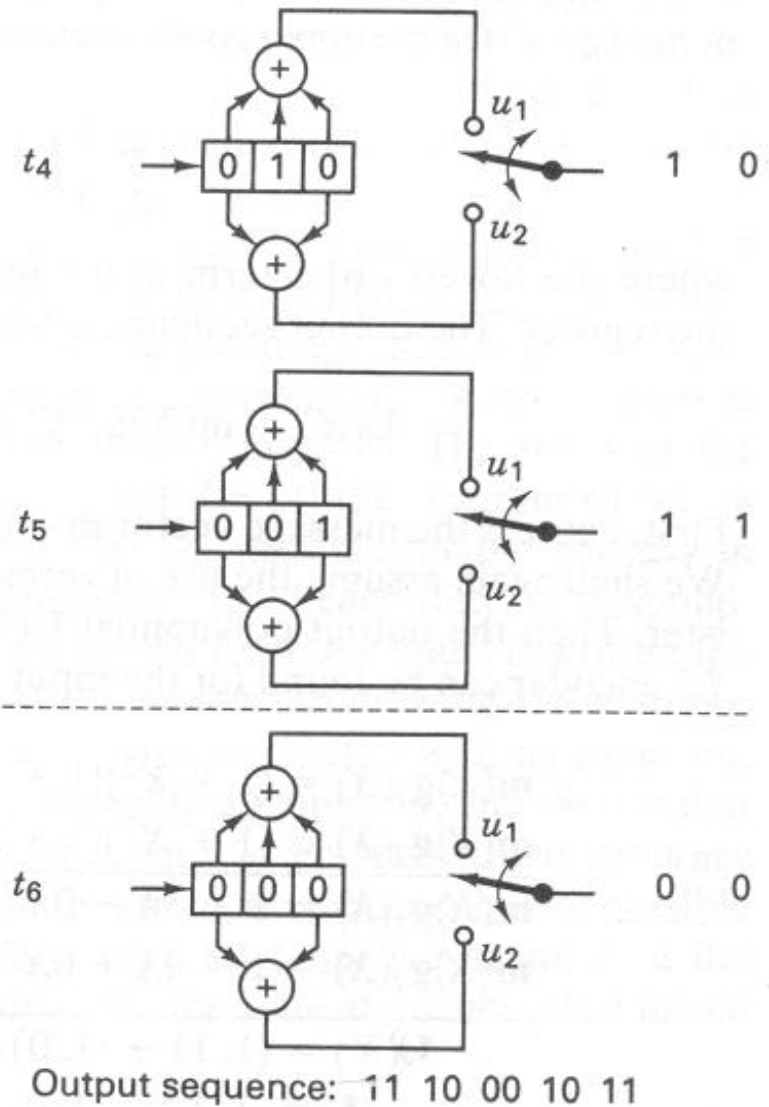
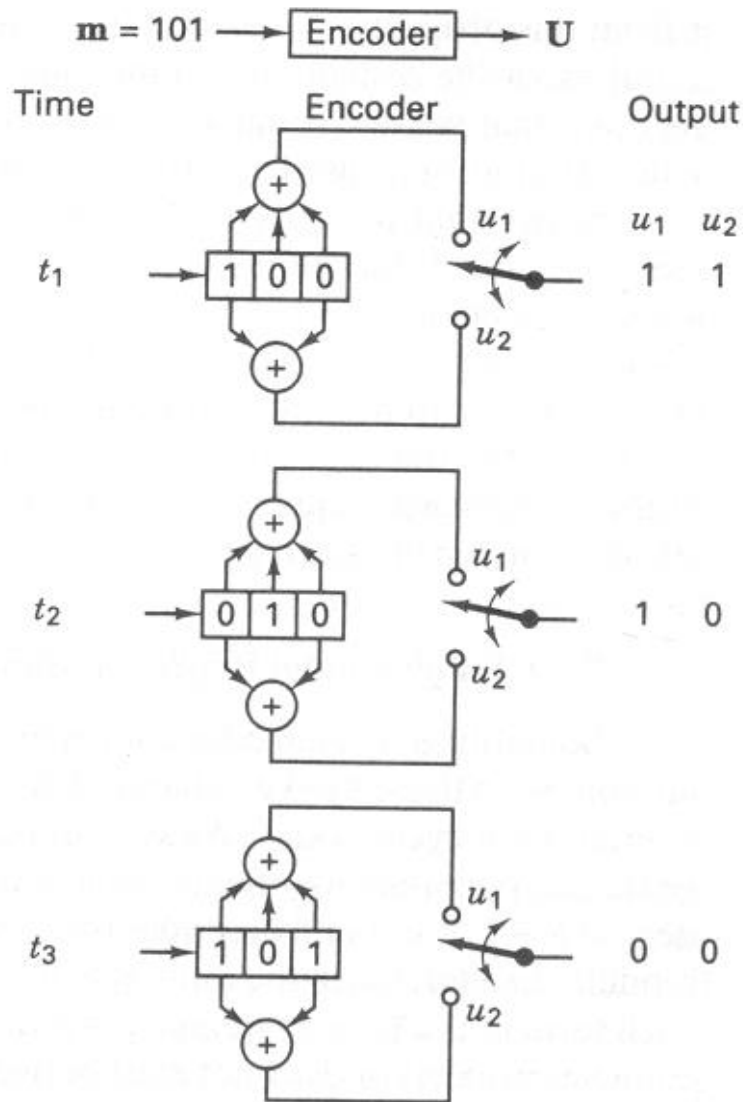

1. 채널코딩(Channel Coding)

Register contents	Branch word	
	u_1	u_2
1 0 0	1	1
0 1 0	1	0
0 0 1	1	1

Input sequence : 1 0 0

Output sequence : 11 10 11

Input $m = 1 0 1$

Input m	Output				
1	1 1	1 0	1 1		
0		0 0	0 0	0 0	
1			1 1	1 0	1 1
Modulo-2 sum:	1 1	1 0	0 0	1 0	1 1

1. 채널코딩(Channel Decoding)

Input data sequence	m:	1	1	0	1	1	...
Transmitted codeword	U:	11	01	01	00	01	...
Received sequence	Z:	11	01	01	10	01	...

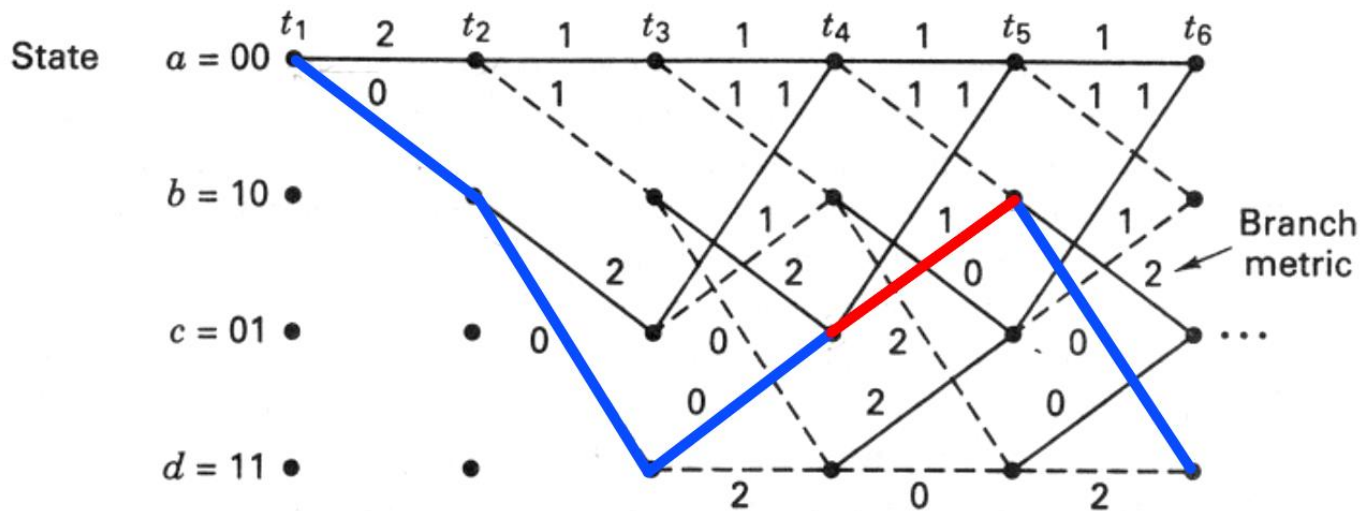

Figure 7.10 Decoder trellis diagram (rate $\frac{1}{2}$, $K = 3$).

HW : 부교재 SKLAR book 393쪽 참조

◆ Interleaving (Burst Error control)

Burst error란?

period of deep fades, long streams of successive or burst error occur

Burst error \Rightarrow Random error transformation

read : row

write : column

Ex) Original message

ARE YOU SURE THAT THEY ARE COMING TO LUNCH WITH US

Interleave matrix

```
AREYOUSURE  
THATTHEYAR  
ECOMINGTOL  
UNCHWITHUS
```

◆ Interleaving (cont.)

- Interleaved message

A TEU RHCN EAOC YTMH OTIW UHNI SEGT UYTH RAOU ERLS

- Interleaved message (with burst error)

A TEU RHCN EAOC YTMH OTIW UHNI SEGT UYTH RAOU ERLS
 - - - - - -

- Reconstructed message (with random error)

A RE YOU SURE THAT ARE COMING TO LUNCH WITH US
- -

◆ Modulation and Demodulation

▷ Digital Modulation 이란?

: The process by which digital symbols are transformed into waveforms that are compatible with the characteristics of the channel.

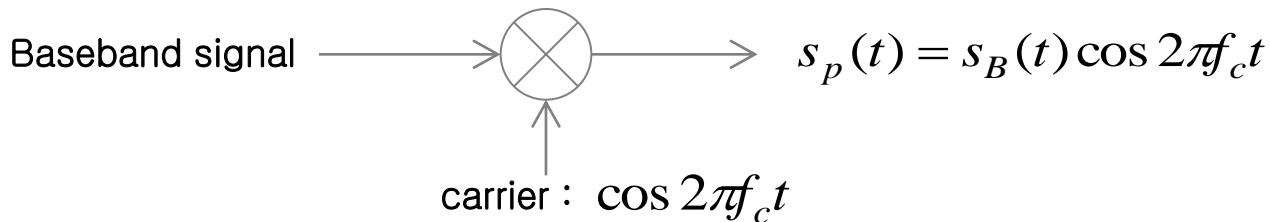

- ▷ Why ?
 - Antenna Size
 - Spectrum available
 - Multiplexing – Separate the different signals

▷ Digital Bandpass Modulation 기술

Coherent

Phase Shift Keying (PSK)
Frequency Shift Keying (FSK)
Continuous Phase Modulation (CPM)
Hybrids

Noncoherent

Differential Phase Shift Keying (DPSK)
Frequency Shift Keying (FSK)
Continuous Phase Modulation (CPM)
Hybrids

Modulation/Demodulation

1. 디지털 변조방식(데이터 1,0,1의 예)

□ ASK(Amplitude Shift Keying)

- ❖ 디지털 데이터(0,1)의 값에 따라서 반송파의 크기 성분을 변화시키는 변조방식

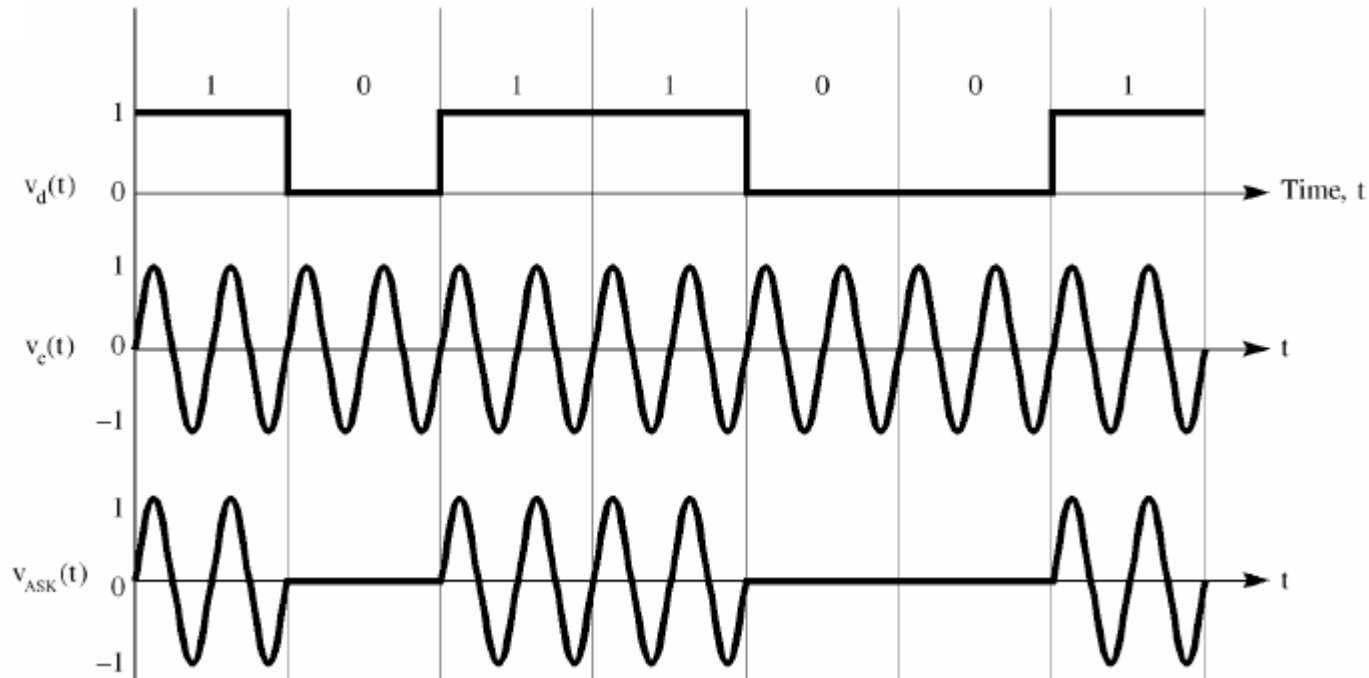

Modulation/Demodulation

1. 디지털 변조방식

□ FSK(Frequency Shift Keying)

- ❖ 복조회로에서는 두 개의 필터에 의해서 서로 다른 두 주파수가 나뉘어지고, 각각의 검파기에 의해서 만들어진 신호를 서로 비교한 후, 에러처리를 위한 회로를 거치게 된다.

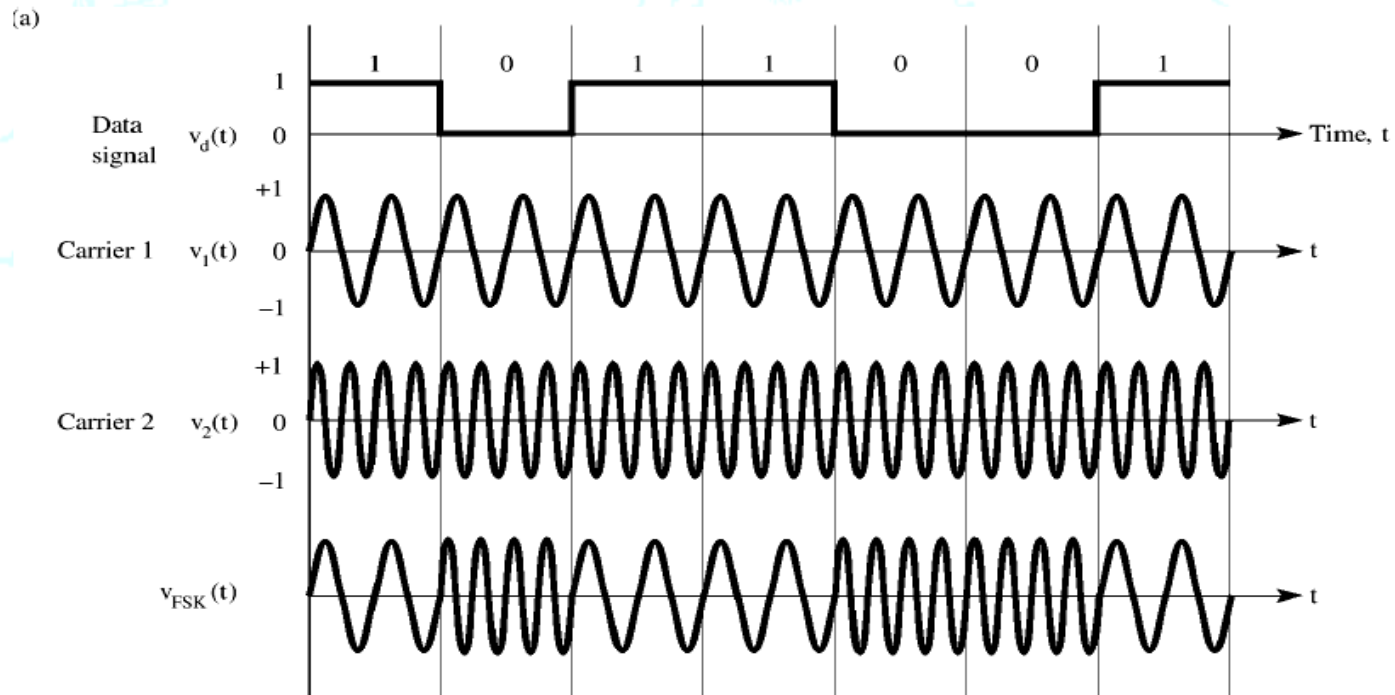

Modulation/Demodulation

1. 디지털 변조방식

□ PSK(Phase Shift Keying)

- ❖ 비트 값이 0일 때에는 주파수 위상을 0으로 놓고, 1일 때는 180도로 바꾼다. 수신측에서는 원래의 반송파의 위상과 비교하여 같으면 0으로, 다르면 1로 인식한다

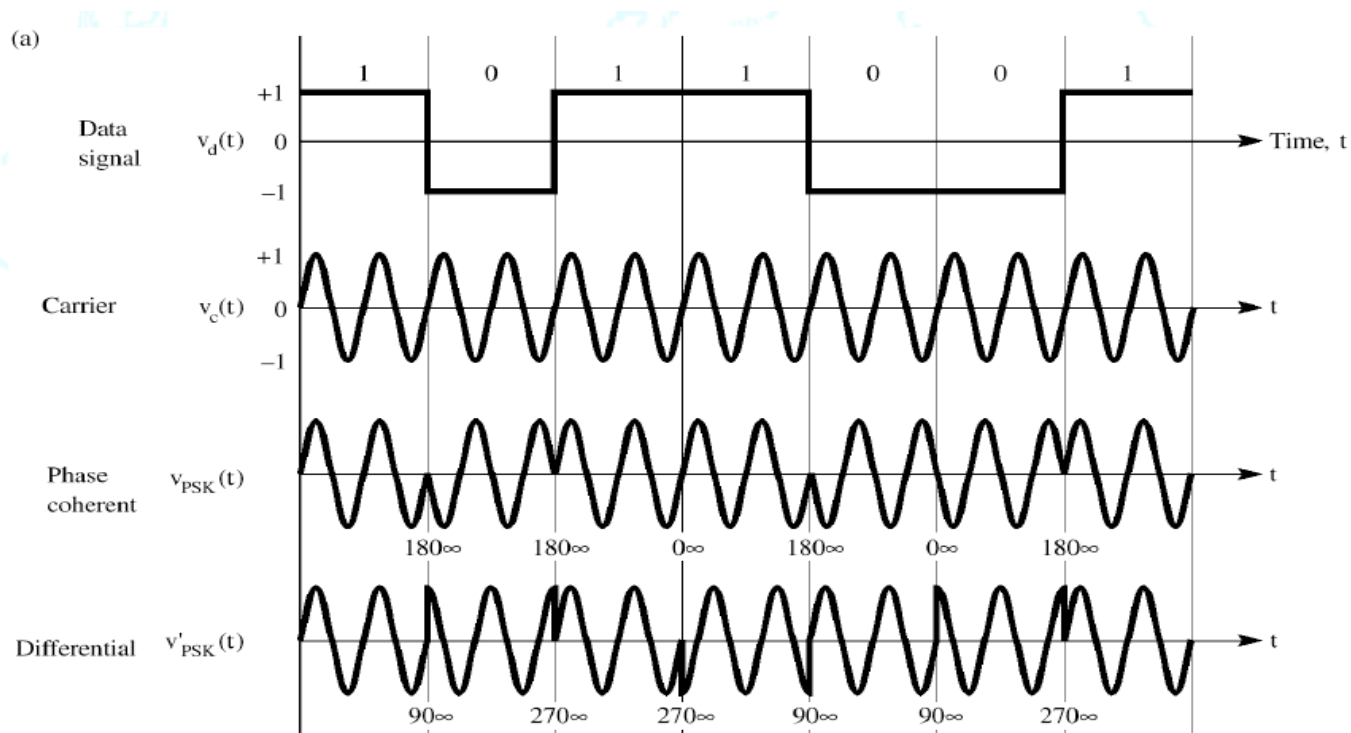

Modulation/Demodulation

1. QAM(Quadrature Amplitude Modulation)

□ 진폭과 위상을 동시에 변화시키는 경우

2. QPSK(Quadrature PSK)

□ 위상을 90도로 변화시켜 2배의 정보를 실어 보냄

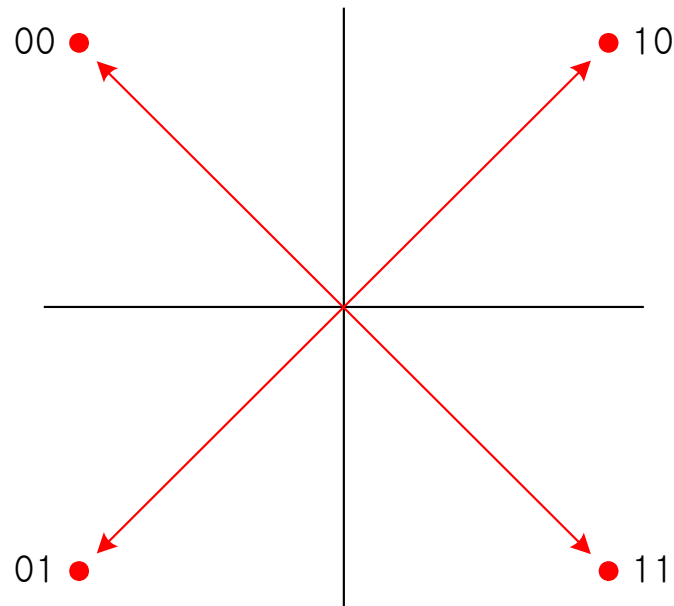

(a) QPSK

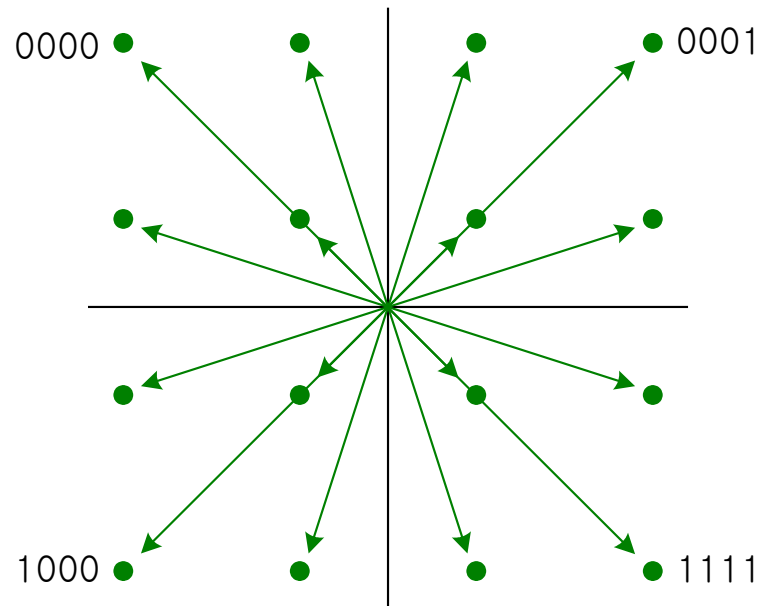

(a) QAM

Modulation/Demodulation

◆ QPSK Modulator

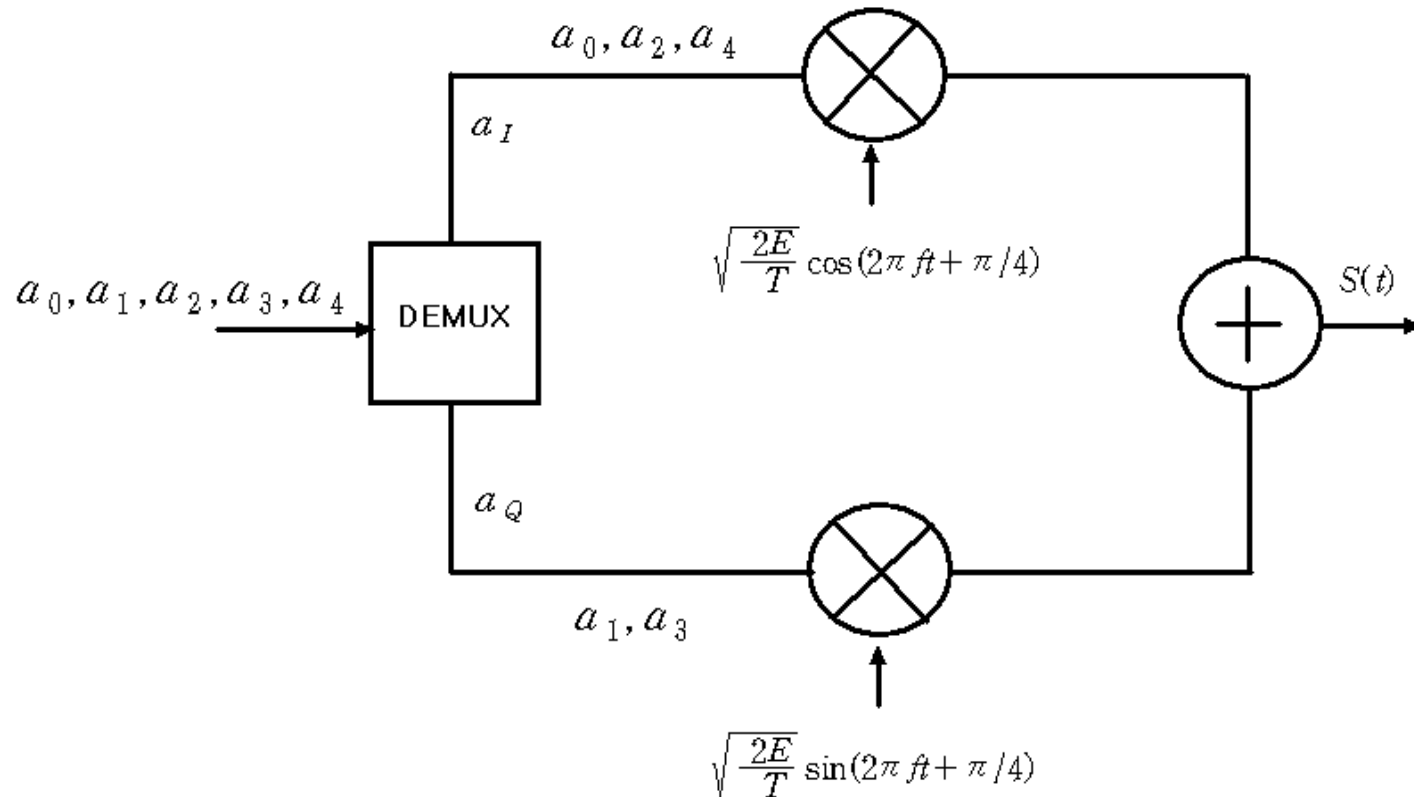

QPSK Modulation

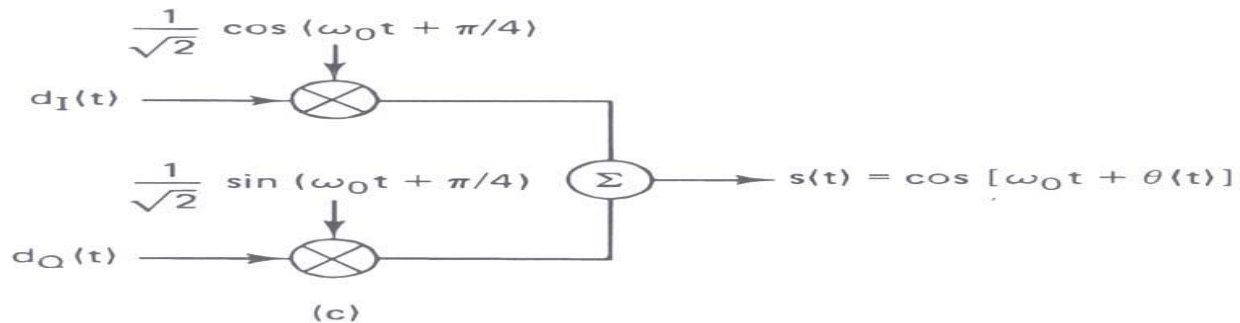
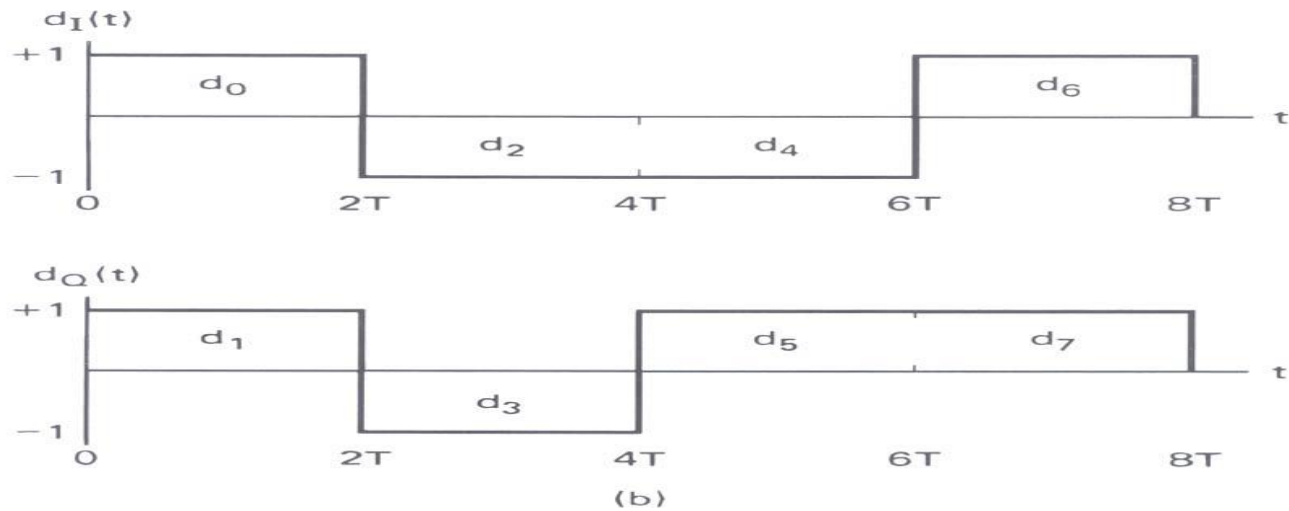
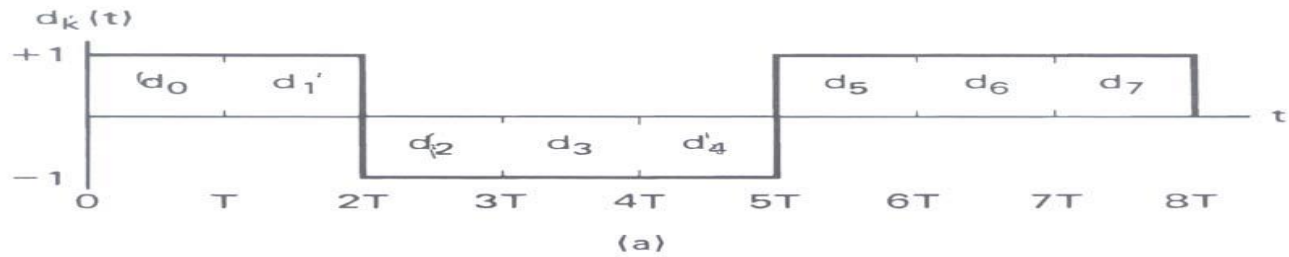

Offset QPSK (OQPSK) data stream

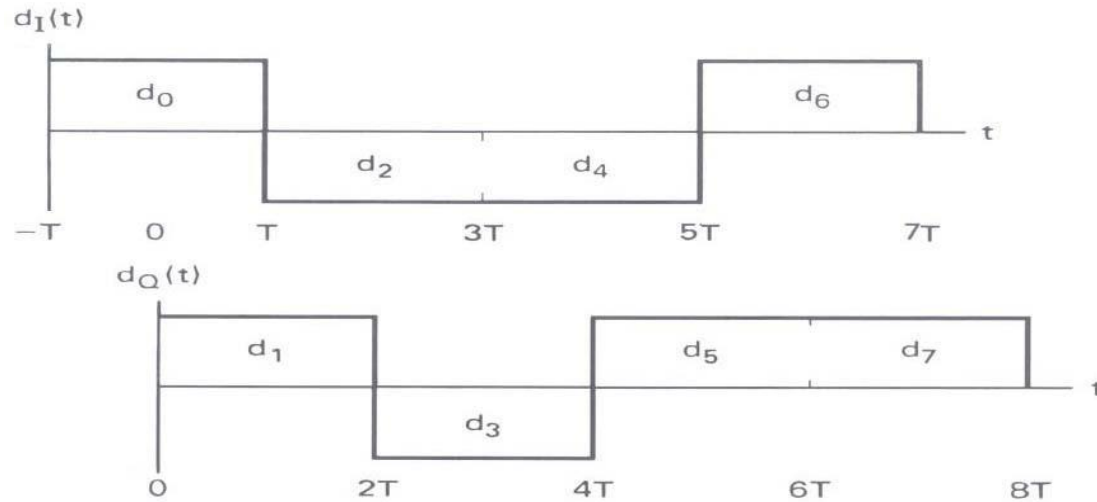

◆ Application in IS-95 CDMA System

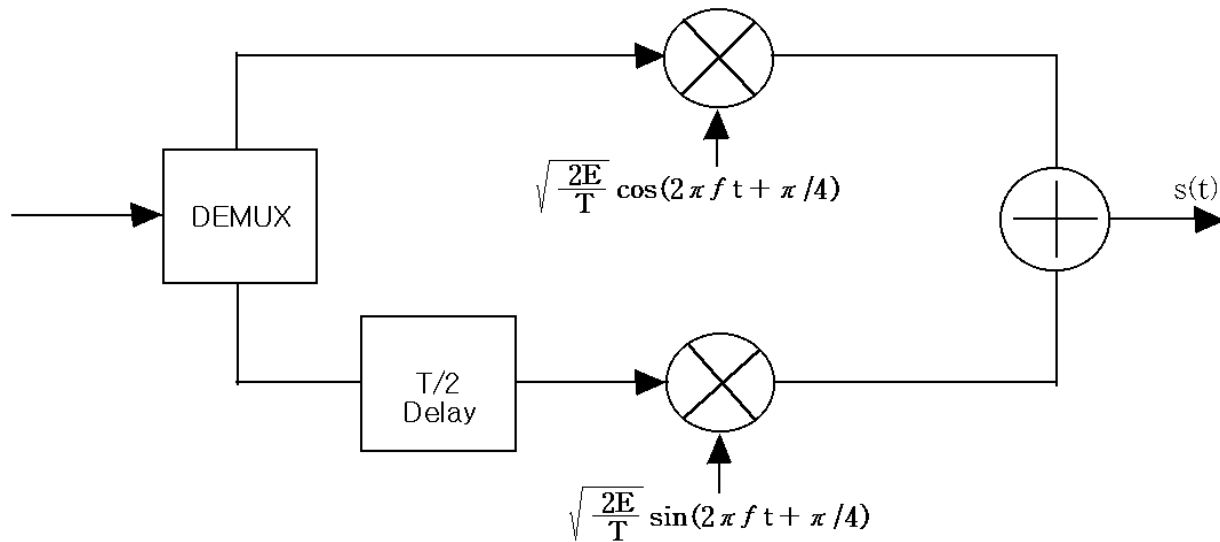

QPSK modulator

Offset QPSK (OQPSK) data stream

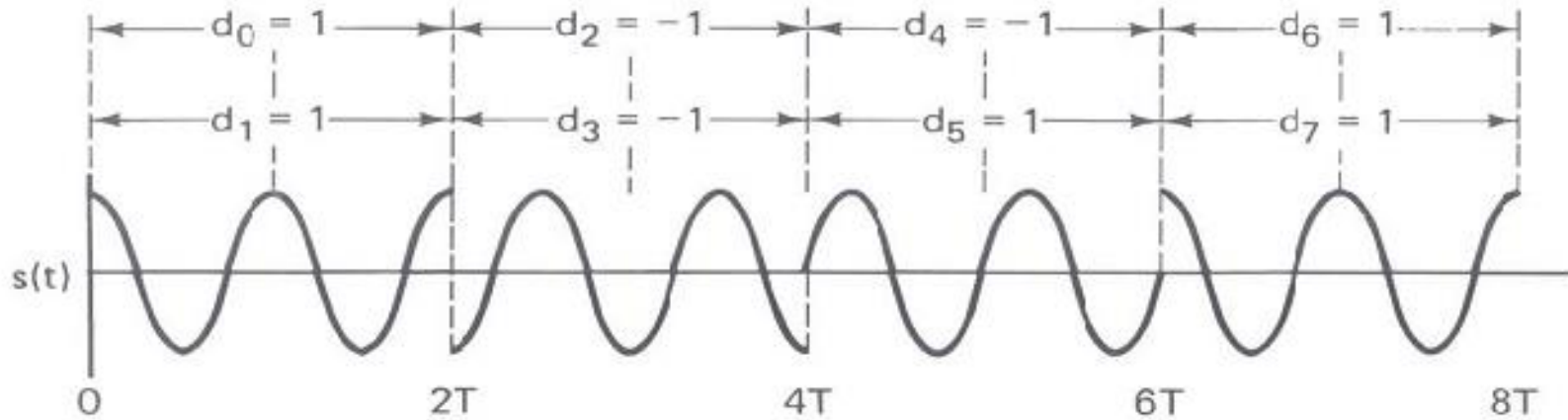

(a) QPSK

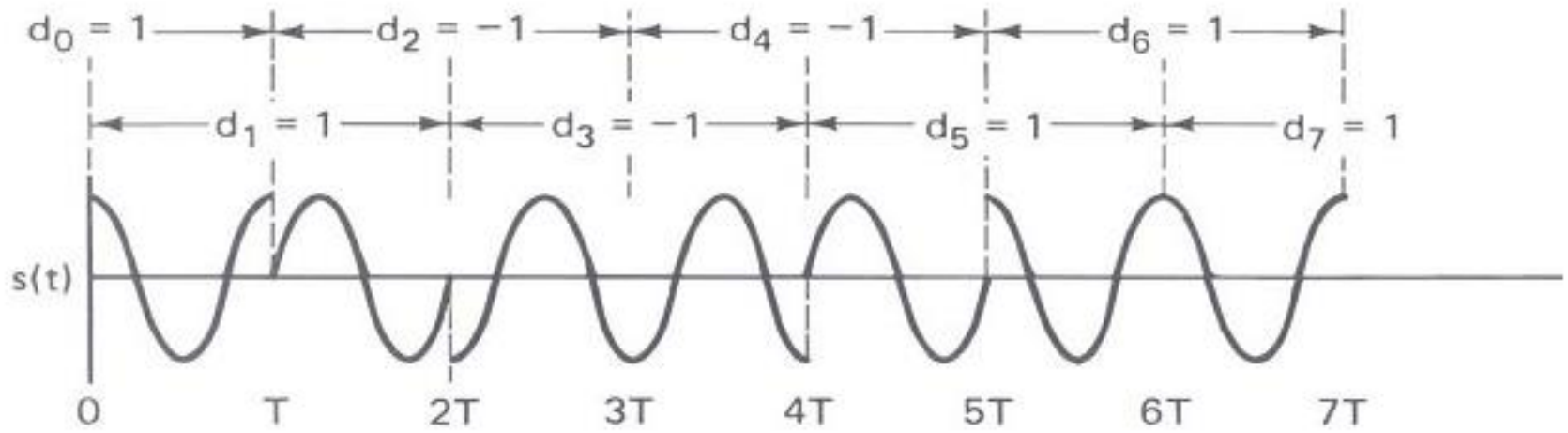

(b) OQPSK

MPSK (Minimum Phase Shift Keying) Modulation

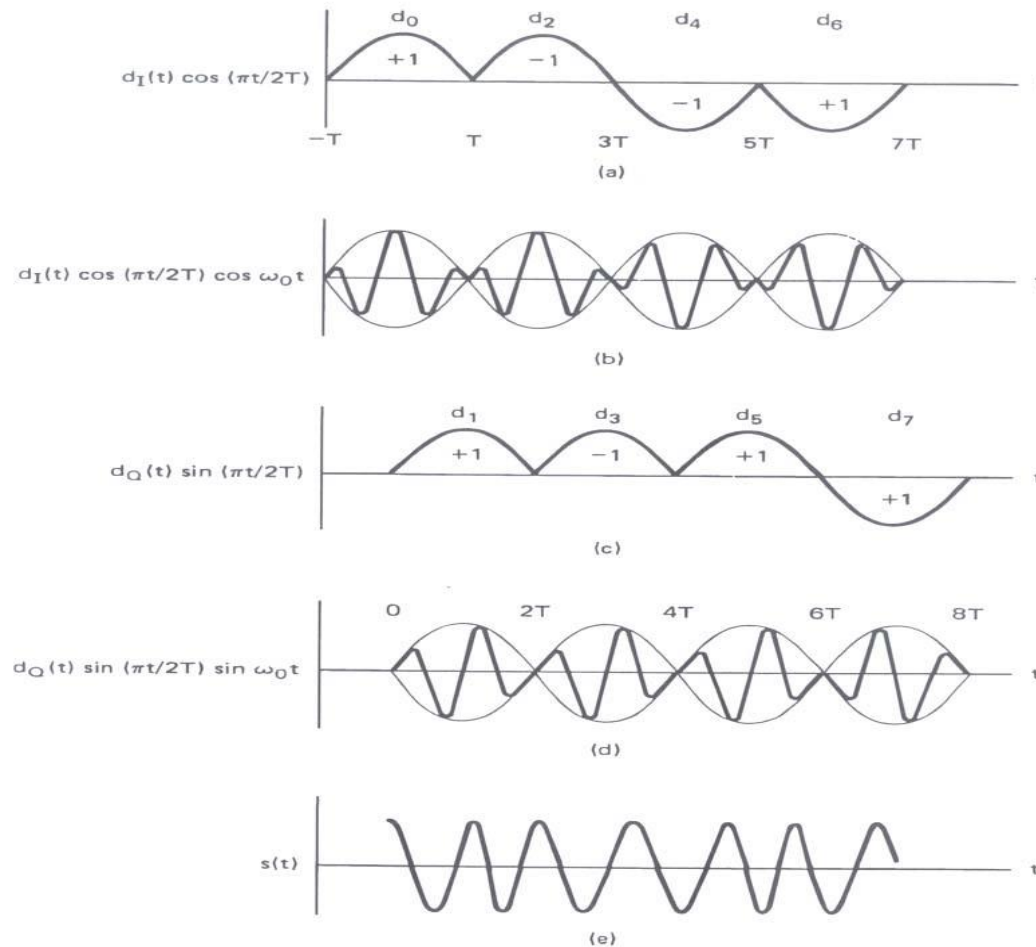

- (a) Modified I bit stream
- (b) I bit stream times carrier
- (c) Modified Q bit stream
- (d) Q bit stream times carrier
- (e) MSK waveform

각 PSK 방식에 따른 대역폭 사용

Trade-offs in System Design :
Data rate vs. Bandwidth

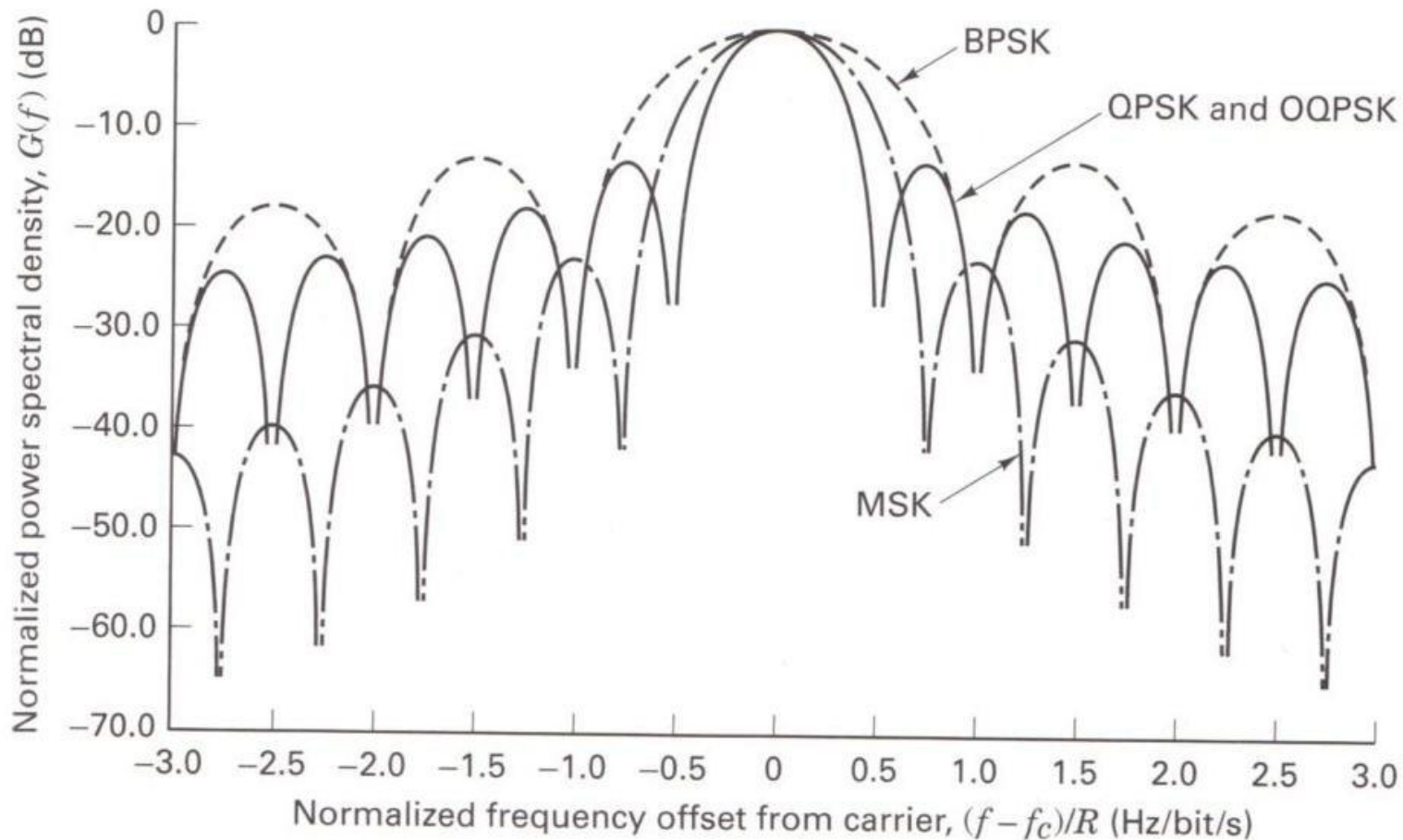

Figure 9.15 Normalized power spectral density for BPSK, QPSK, OQPSK, and MSK. (Reprinted with permission from F. Amoroso, "The Bandwidth of Digital Data Signals," *IEEE Commun. Mag.*, vol. 18, no. 6, Nov. 1980, Fig. 2A, p. 16. © 1980 IEEE.)

◆ Detection of Signals in Gaussian Channel Noise

- ▷ Consider a binary system during a given signaling interval.
The transmitted signal over a system over a symbol interval $(0, T)$ is represented by

$$\begin{aligned} s_i(t) &= s_1(t), & 0 \leq t \leq T & \quad \text{For a binary 1} \\ &= s_2(t), & 0 \leq t \leq T & \quad \text{For a binary 0} \end{aligned}$$

- ▷ The Received Signal by the Receiver is represented by

$$r(t) = s_i(t) + n(t), \quad 0 \leq t \leq T, \quad i = 1, 2, \dots, M$$

$s_i(t)$ 는 송신신호이고, $n(t)$ 는 확률밀도함수(probability density function)가 Gaussian 분포를 가지는 random noise임 (Zero-mean AWGN). 따라서 수신신호 $r(t)$ 는 random 신호.

Two basic steps in digital signal detection

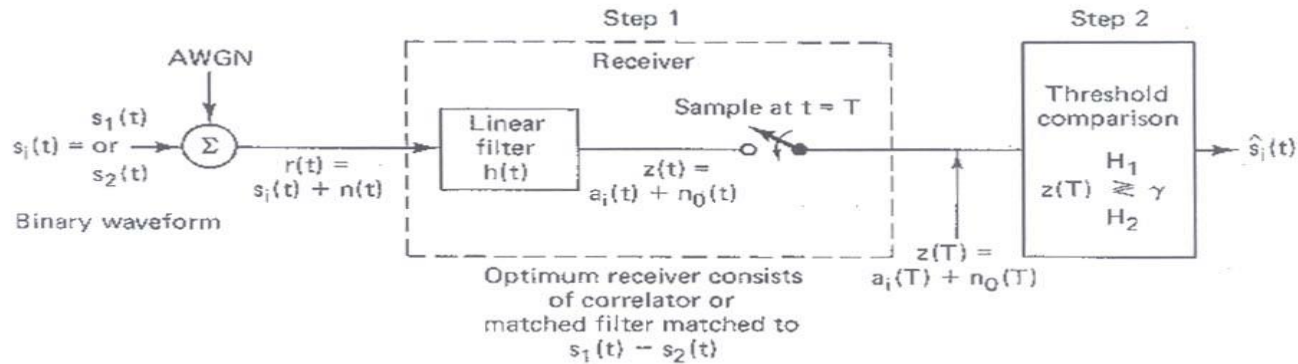

▷ Separate Detection Steps (Binary detection 예)

Step 1 : $r(t)$ 를 Single Random Variable $z(t)$ 로 변환.

(Transforming waveform into a point in the decision region)

: 복조기에서 Matched Filters or Correlators로 구현.

- The signal after lowpass filtering

$$z(t) = a_i(t) + n_0(t)$$

- Test Statistic after sampler

$$z(T) = a_i(T) + n_0(T)$$

#HW : SKLAR book 122쪽 Matched filter 참조

Signal Detection (Step 1 cont.)

Since noise component, n_0 , is a zero-mean Gaussian random variable, the $z(T)$ is a Gaussian random variable with mean of either a_1 or a_2 depending on a binary one or binary zero was sent.

–The p.d.f of Gaussian random noise,

$$P(n_0) = \frac{1}{\sigma_0 \sqrt{2\pi}} \exp \left[-\frac{1}{2} \left(\frac{n_0}{\sigma_0} \right)^2 \right]$$

–The conditional p.d.f. of $z(T)$ given that $s_1(t)$ was transmitted

$$P(z / s_1) = \frac{1}{\sigma_0 \sqrt{2\pi}} \exp \left[-\frac{1}{2} \left(\frac{z - a_1}{\sigma_0} \right)^2 \right]$$

–The conditional p.d.f. of $z(T)$ given that $s_2(t)$ was transmitted

$$P(z / s_2) = \frac{1}{\sigma_0 \sqrt{2\pi}} \exp \left[-\frac{1}{2} \left(\frac{z - a_2}{\sigma_0} \right)^2 \right]$$

Signal Detection (Step 1 cont.)

Step 2 : Compare the test statistic to threshold level γ_0 in order to estimate which signal $s_1(t)$ or $s_2(t)$ has been sent.

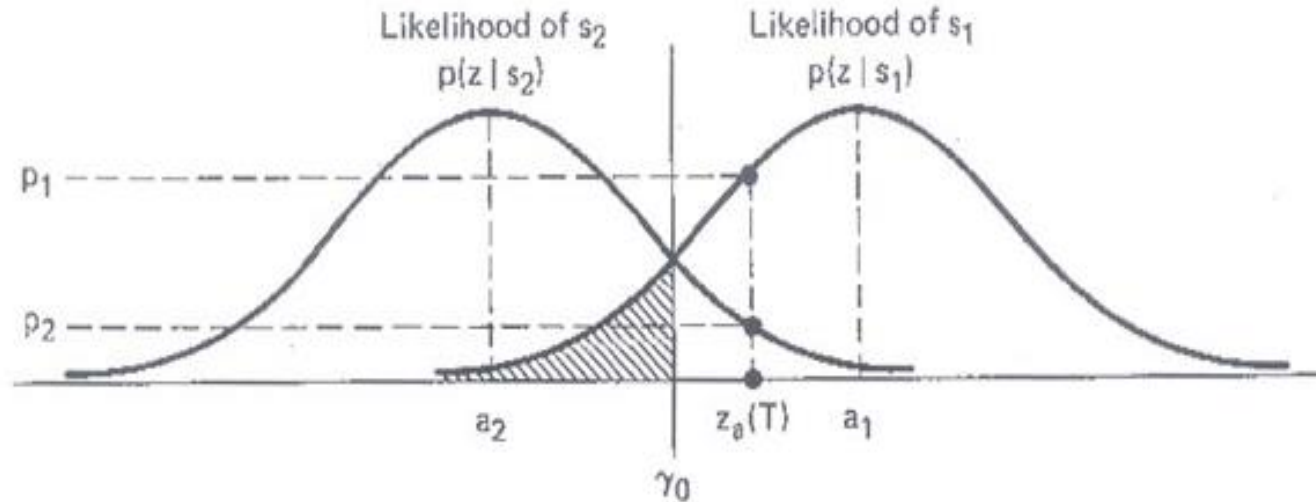

Figure Conditional probability density functions: $p(z|s_1)$ and $p(z|s_2)$.

Step 3 : Make a decision whether '0' or '1' Sent

$$z(T) \begin{matrix} H_1 \\ \gtrsim \\ H_2 \end{matrix} \gamma_0$$

H_1, H_2 : hypothesis

$H_1 \equiv$ deciding that signal $s_1(t)$ was sent.

Hypothesis H_1 is chosen $z(T) > \gamma_0$

▷ Signal Space and Decision Regions for a QPSK System

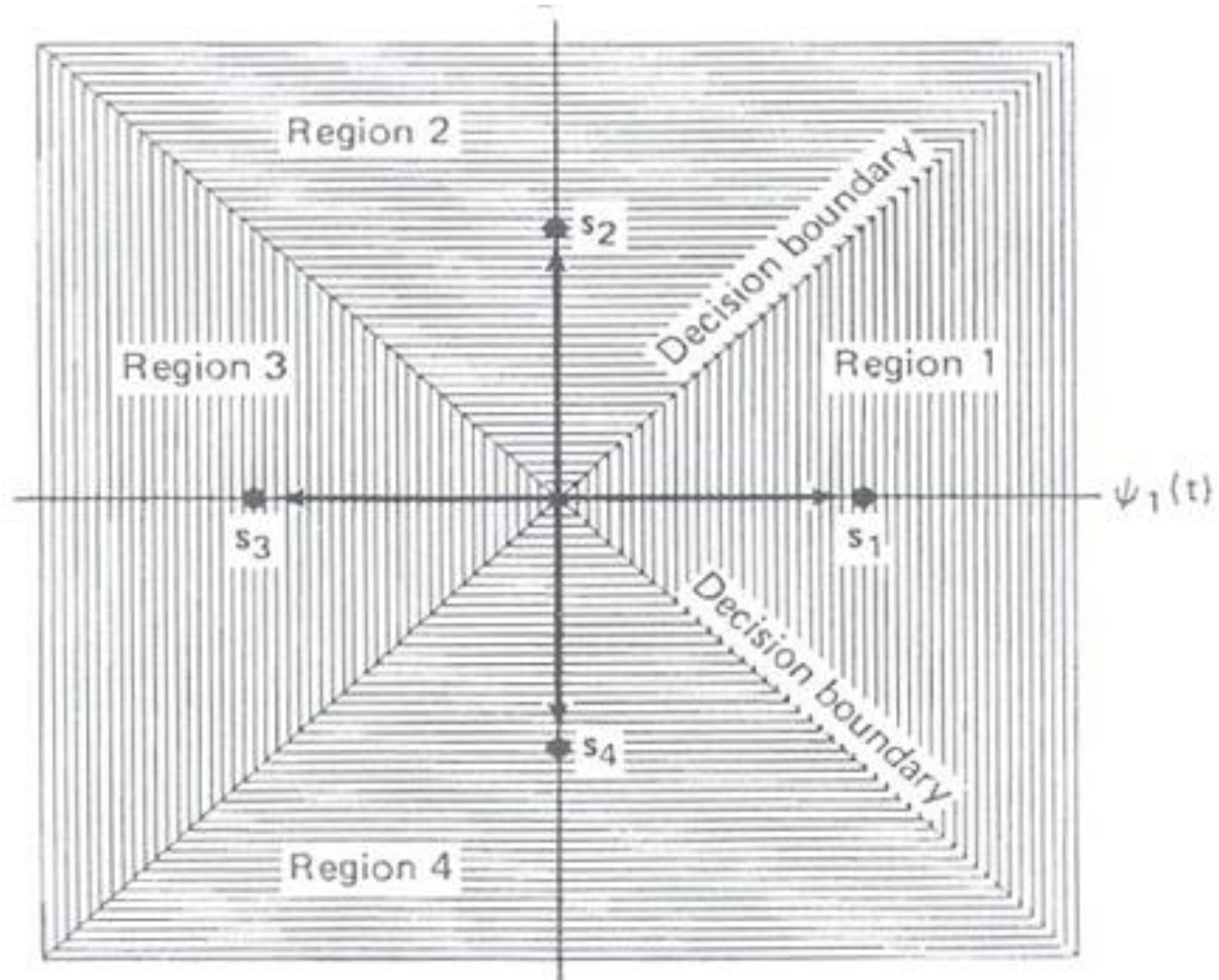

Correlator Receiver for detection

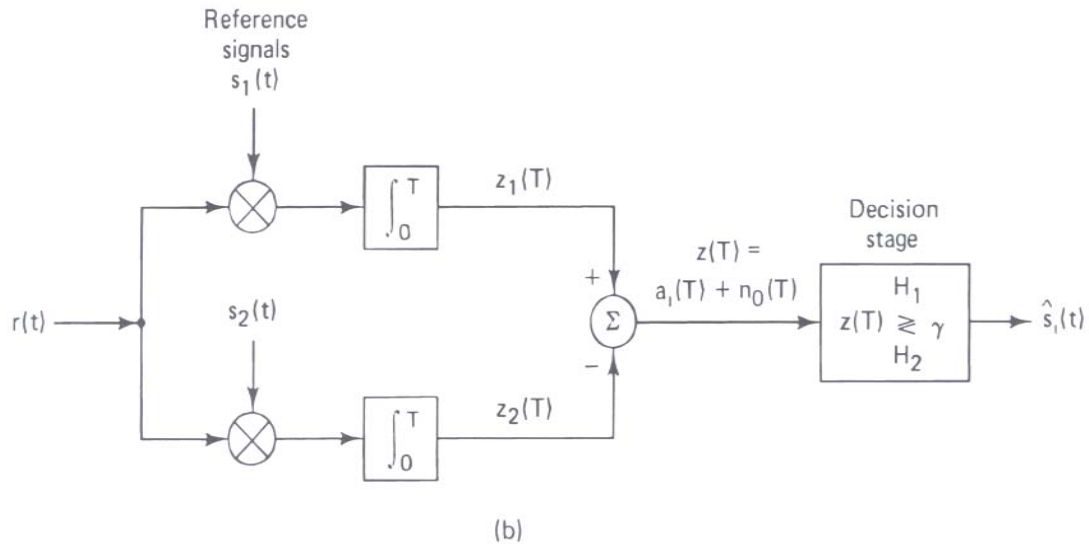
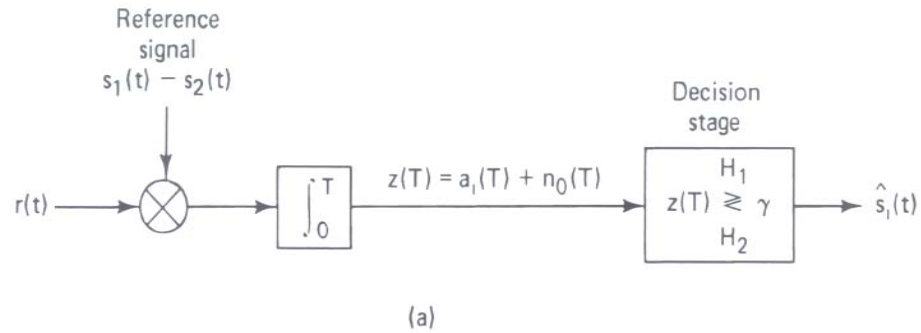

- Binary correlator receiver
- (a) Using a single correlator
 - (b) Using two correlators

Correlator Receiver (cont.)

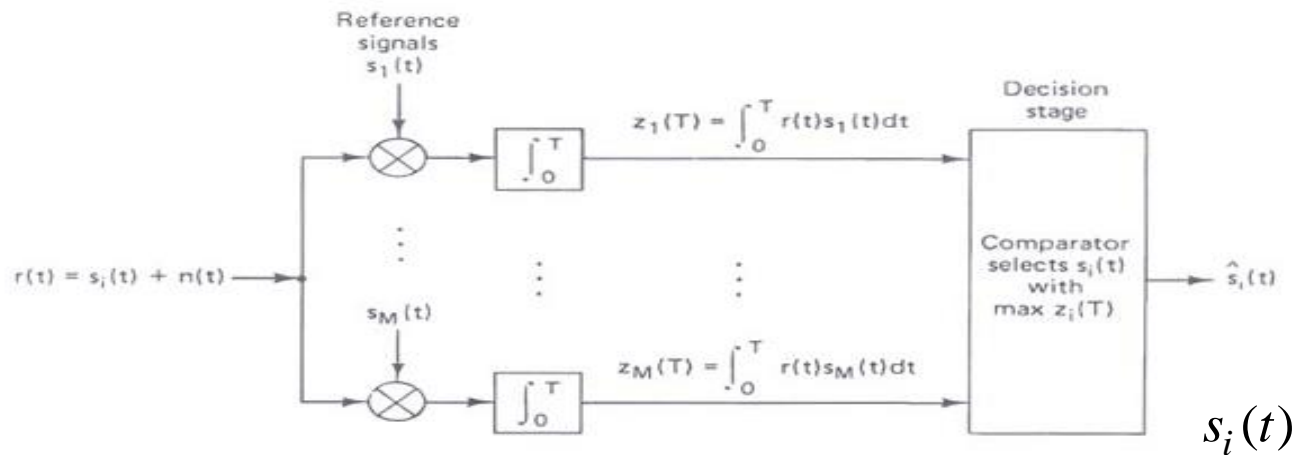

Correlator receiver with TXed reference signal,

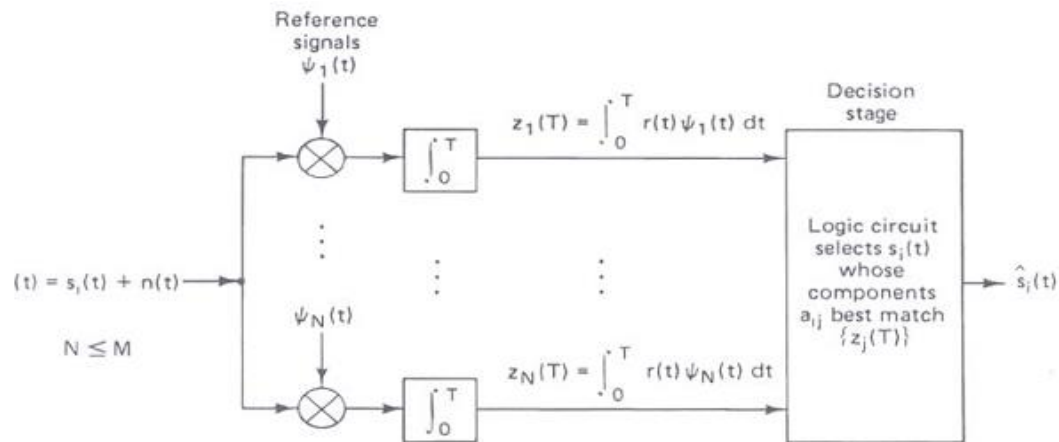

Correlator receiver with reference signals, $\psi_i(t)$

Demodulator for QPSK signals

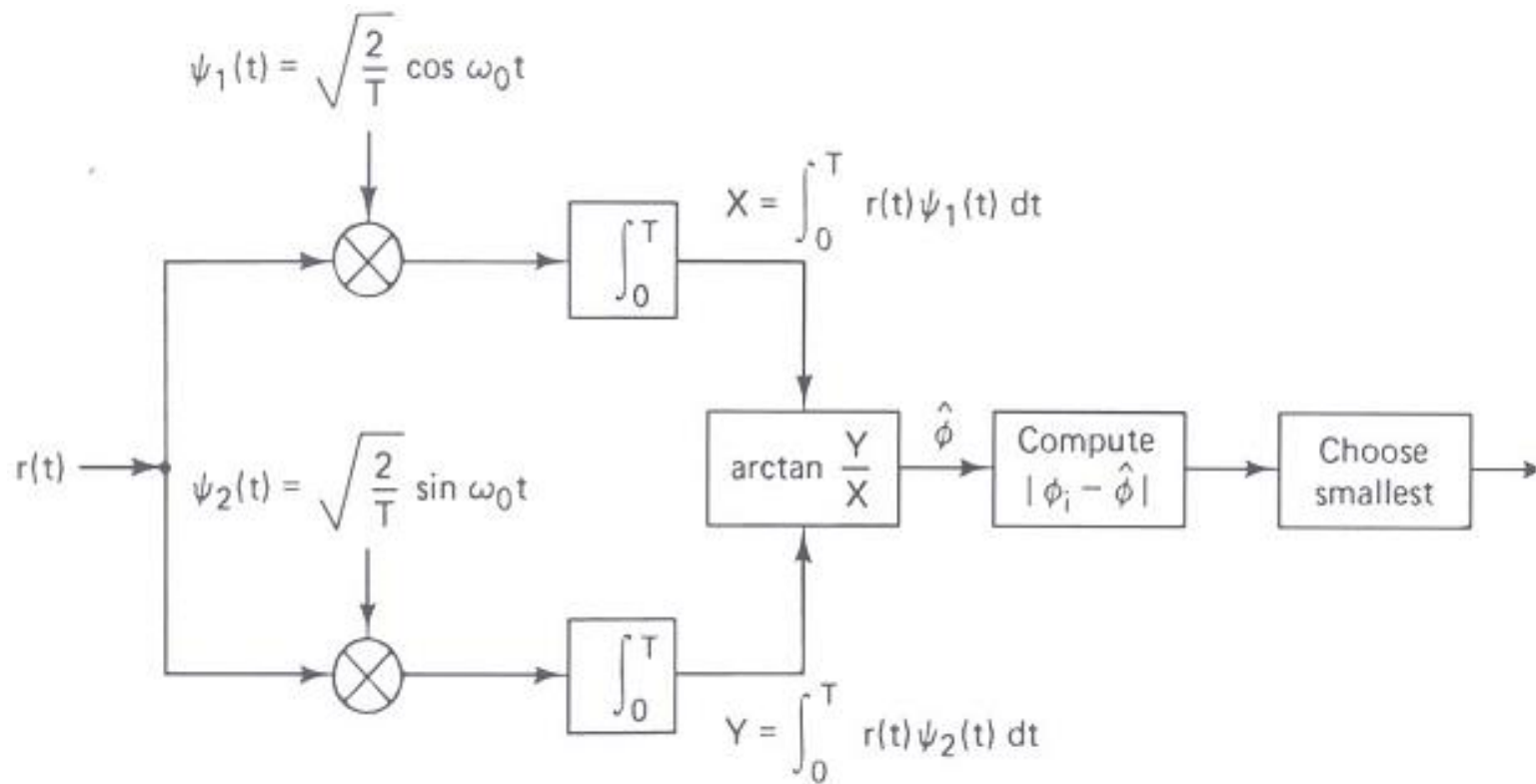

Modulation 기법 비교

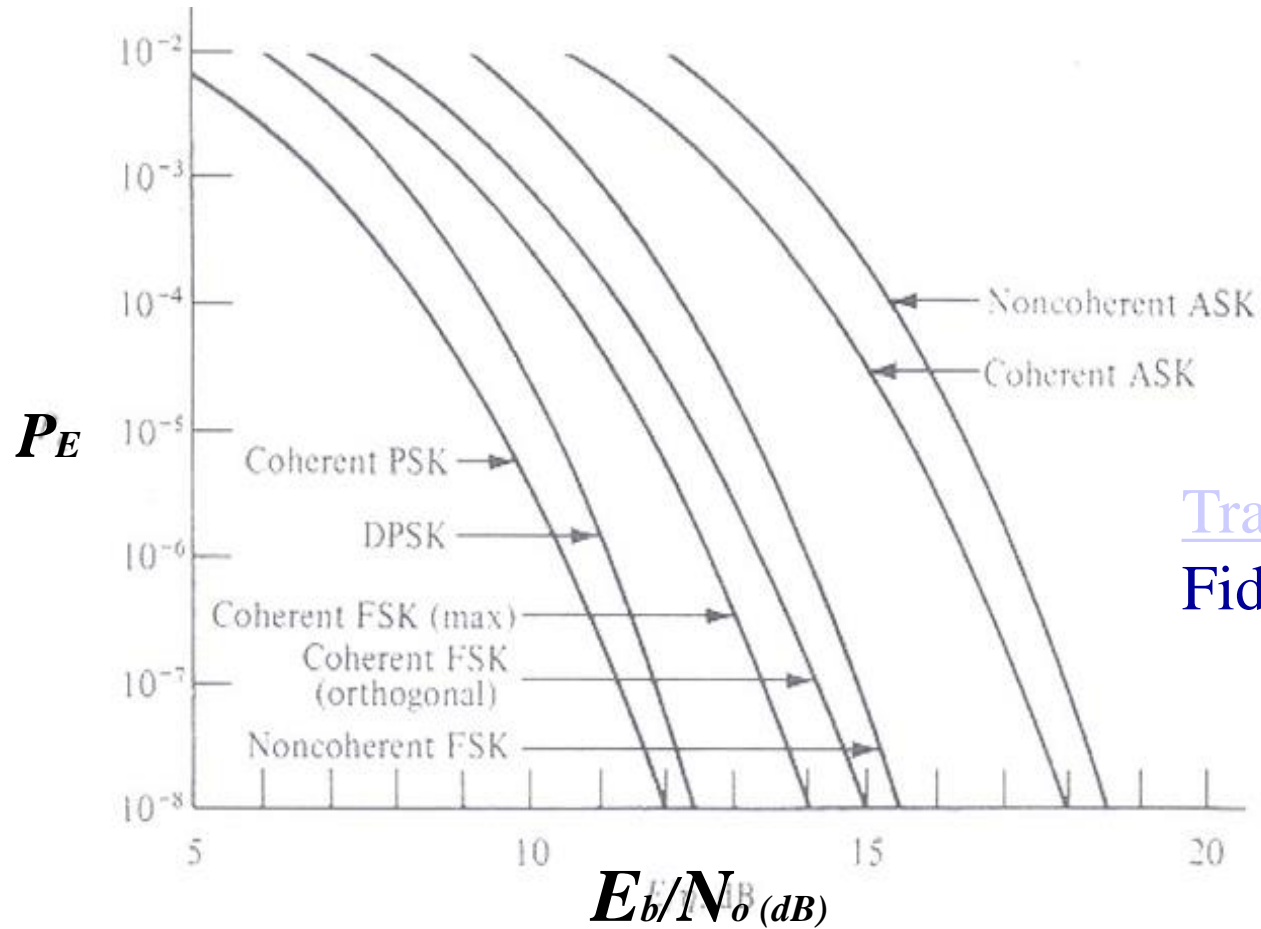

Trade-offs
Fidelity vs. Power

Error probabilities for binary modulation systems

OFDM

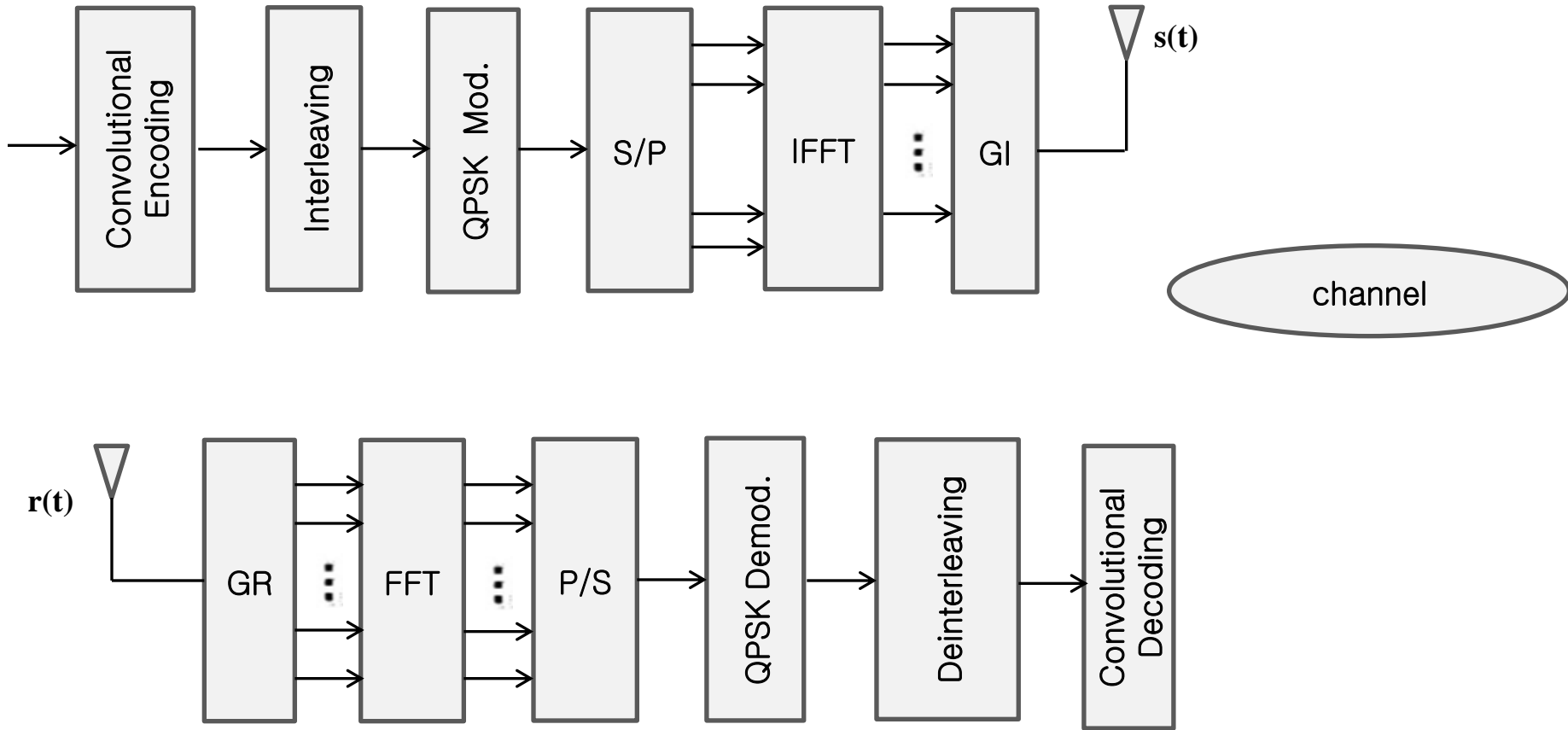

**Channel coding(Convolutional coding & Block Interleaving)을 적용한
OFDM 시스템 모델**

OFDM

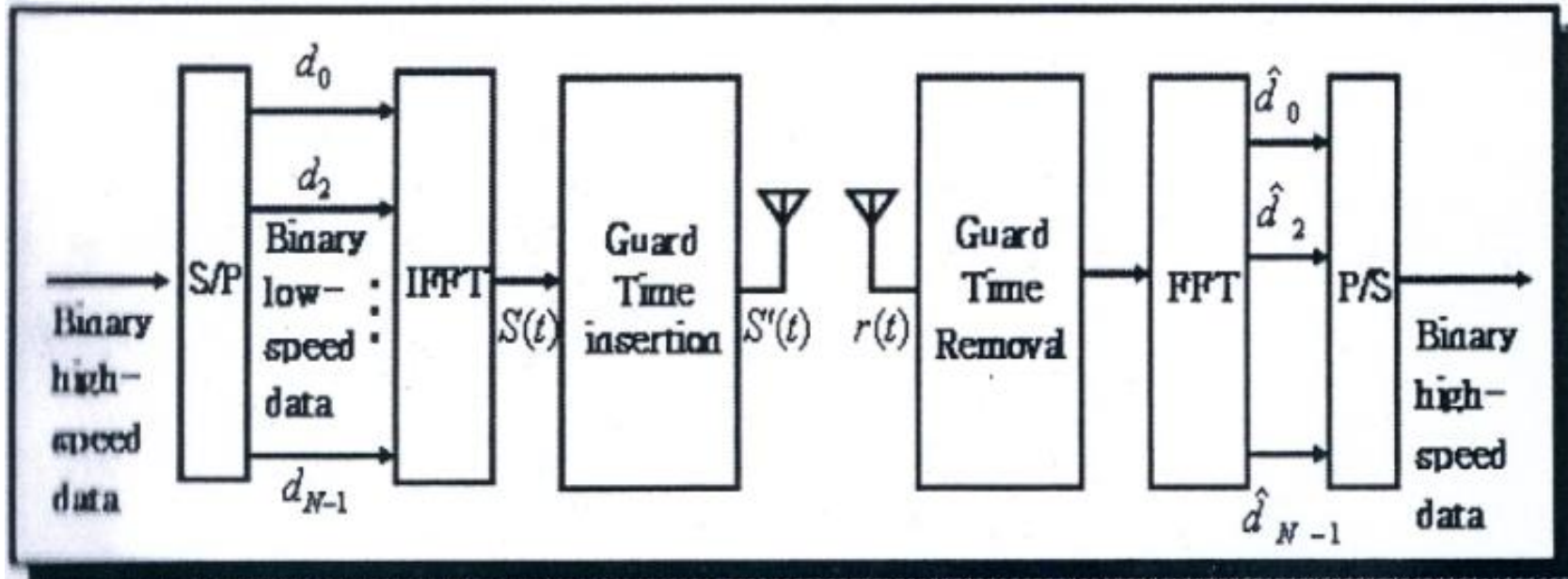

OFDM 시스템의 기본 모델

OFDM

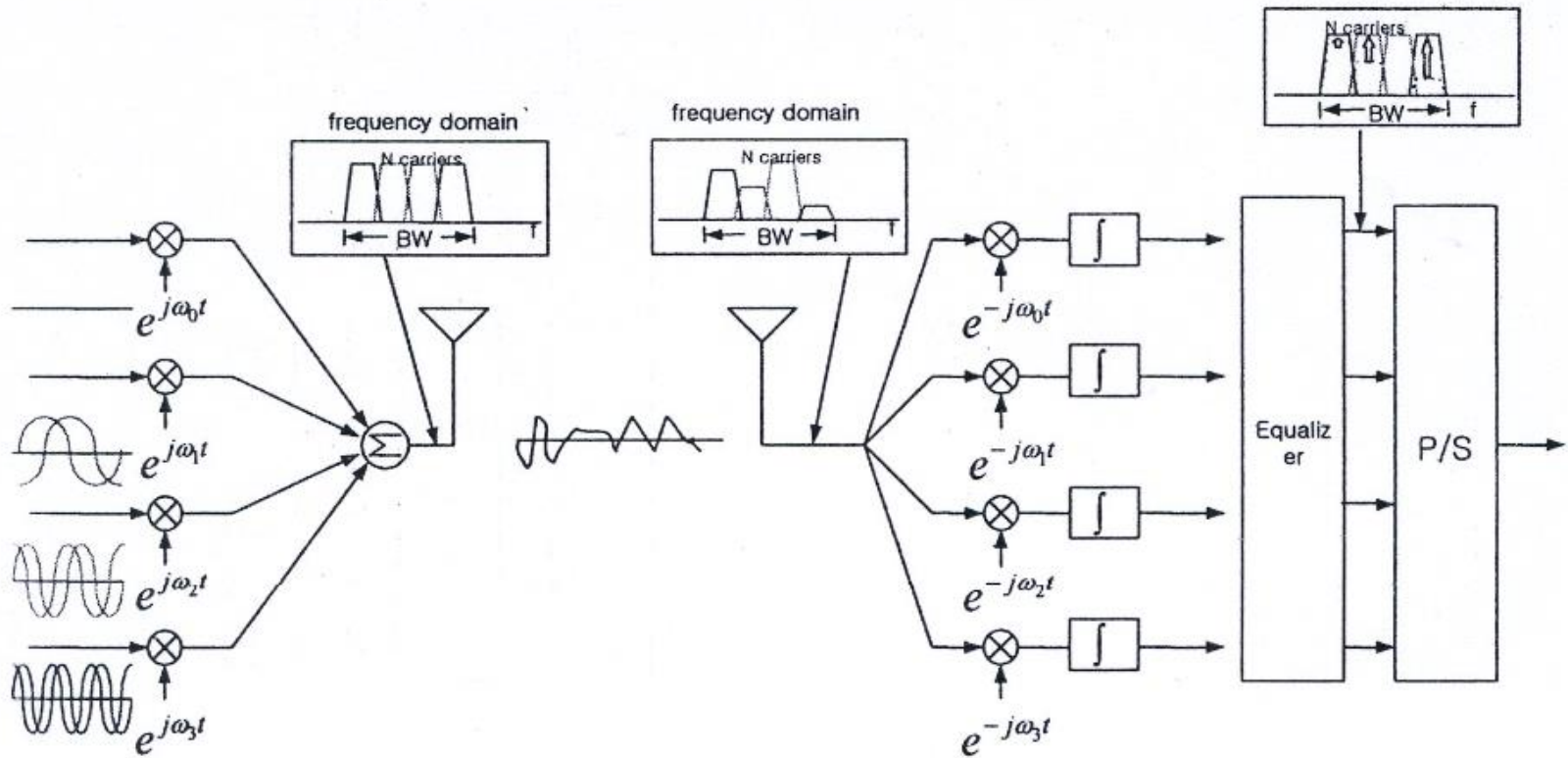

Multicarrier 송수신의 기본구조

Spread Spectrum

1. A digital communication system is considered to be a SS system

- ❖ The transmitted signal occupies a bandwidth that is larger than the minimum bandwidth required to transmit the information
- ❖ The bandwidth spread is accomplished by means of a code which is independent of the data
- ❖ At the receiver, de-spreading is accomplished by the correlation of the received spread signal with a synchronized replica of the spreading signal

Note) The definition rules out FM systems because their bandwidth depends on the bandwidth of the source.

Spread Spectrum

1. A major thrust in wide-spread development activity in small scale spread-spectrum networks came from the 1985 FCC ruling(part15) to allow low power unlicensed spread-spectrum radios in ISM (Industry, Science, Medical)band.
2. Maximum allowed unlicensed power output in the ISM bands is limited to 10mW/MHz and the minimum bandwidth, processing gain and hopping rates are specified.

carrier frequencies	bandwidth
902 ~ 928 MHz	26 MHz
2.4 ~ 2.4835 GHz	83.5 MHz
5.725 ~ 5.850 GHz	125 MHz

-ISM bands in 900,2400,5700MHz range-

Frequency Spreading

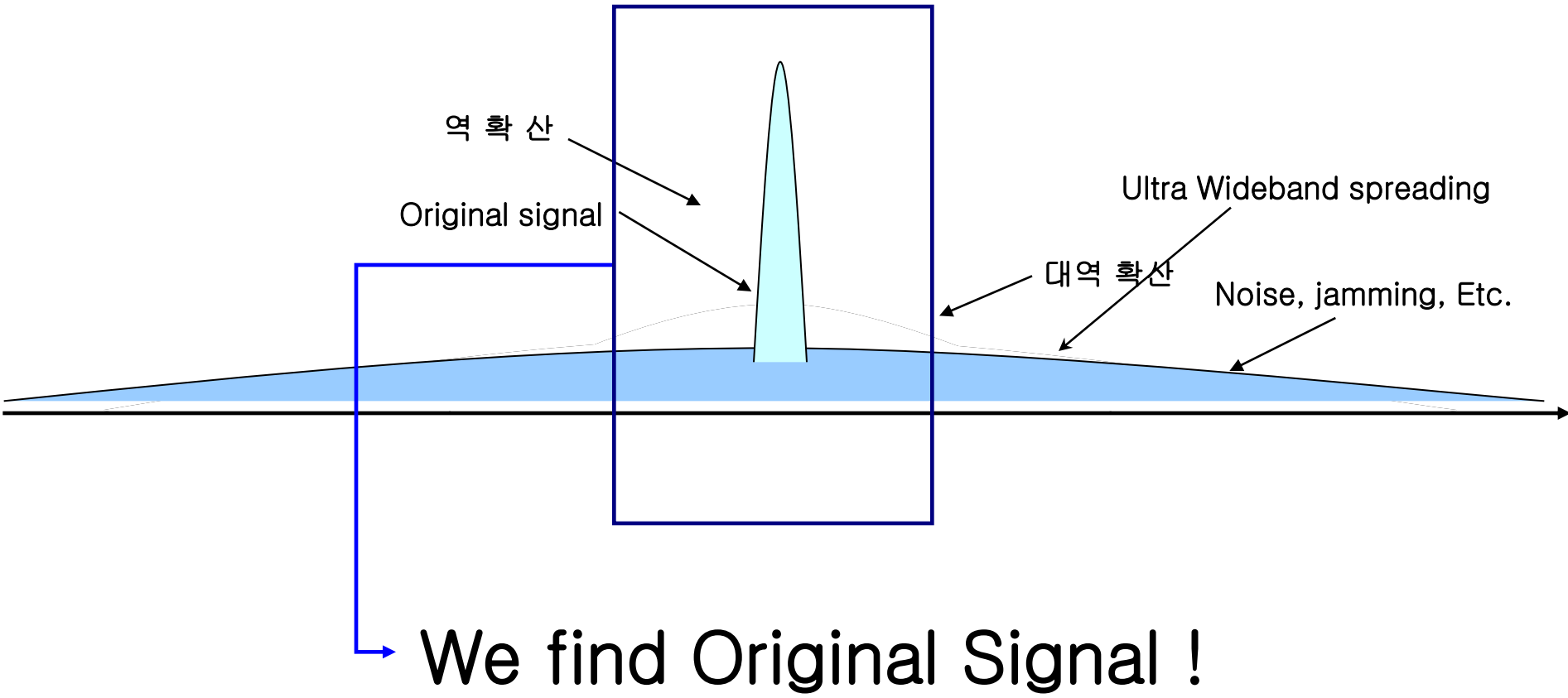

1. 주파수분할 다중화(Frequency Division Multiplexing : FDM)

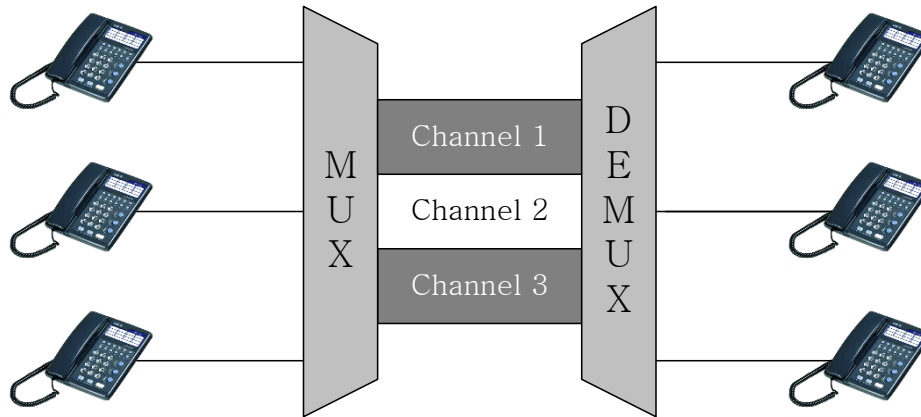

2. 시분할 다중화(Time Division Multiplexing : TDM)

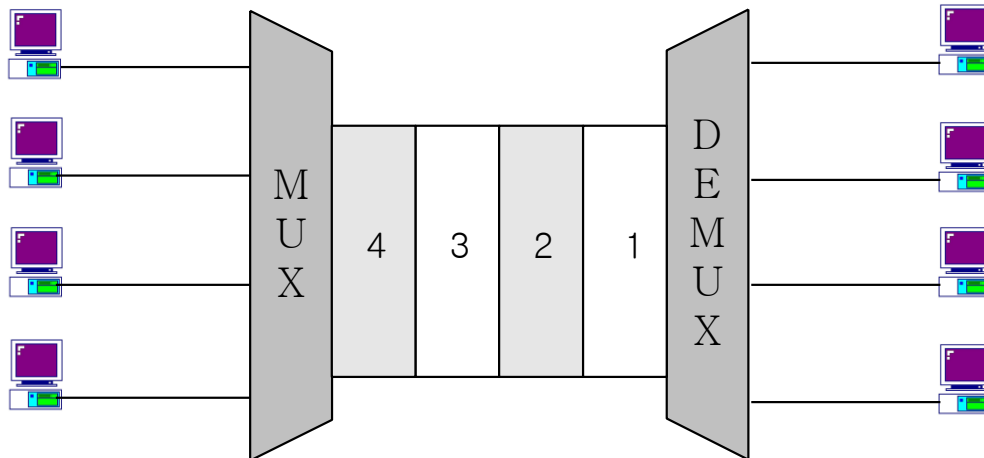

- FDM multiplexing process, time domain

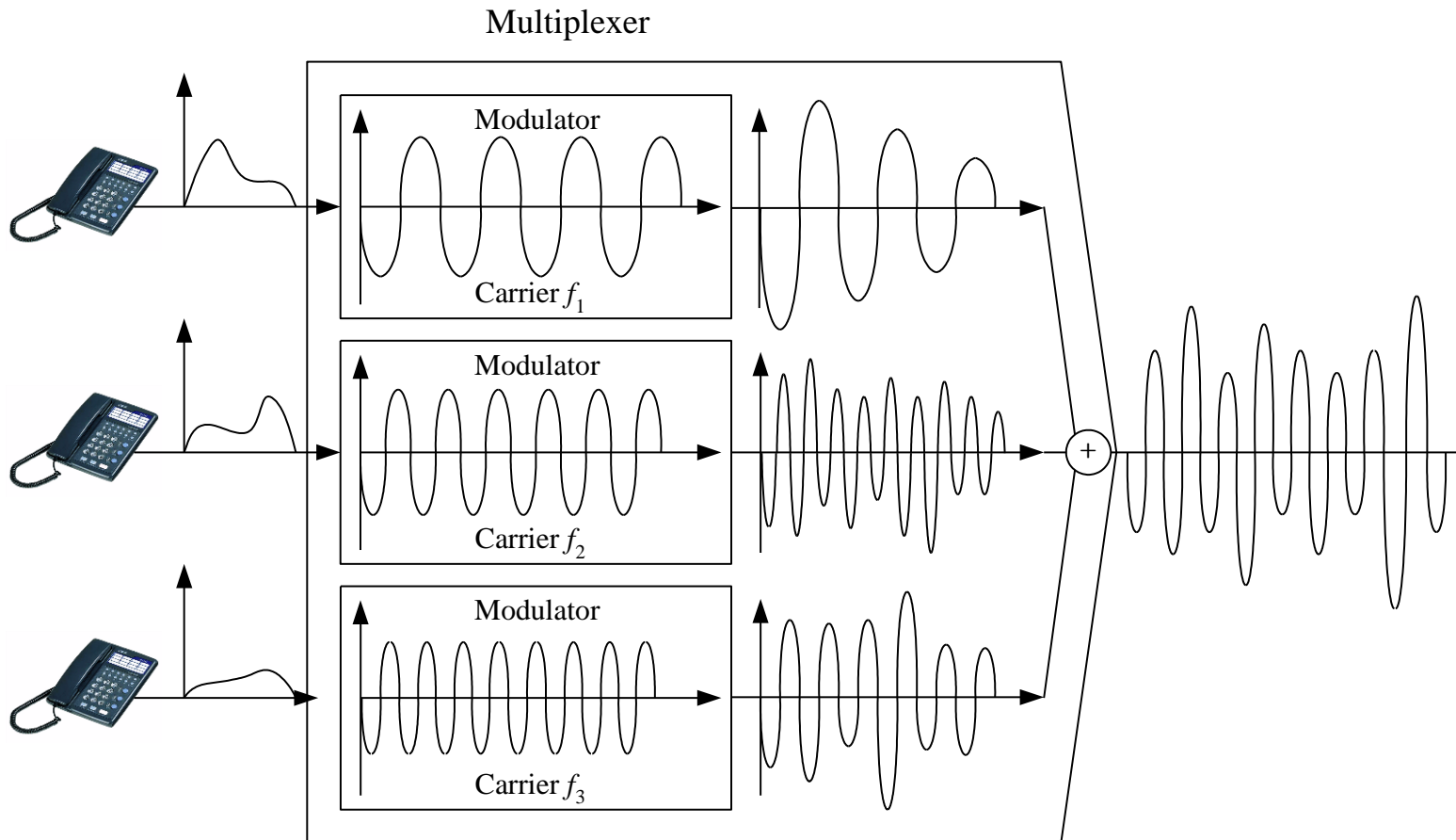

- FDM multiplexing process, frequency domain

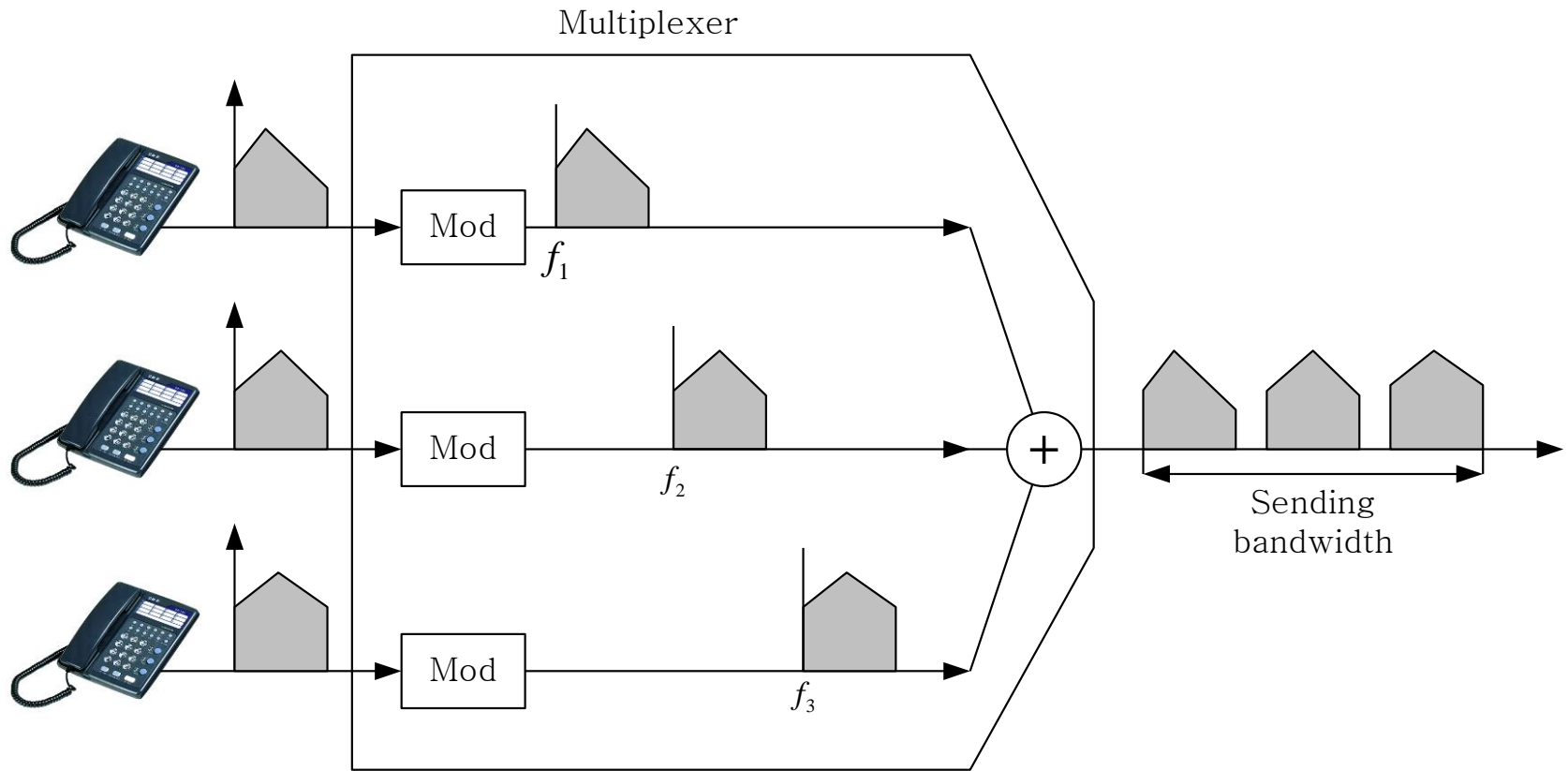

- FDM demultiplexing process, time domain

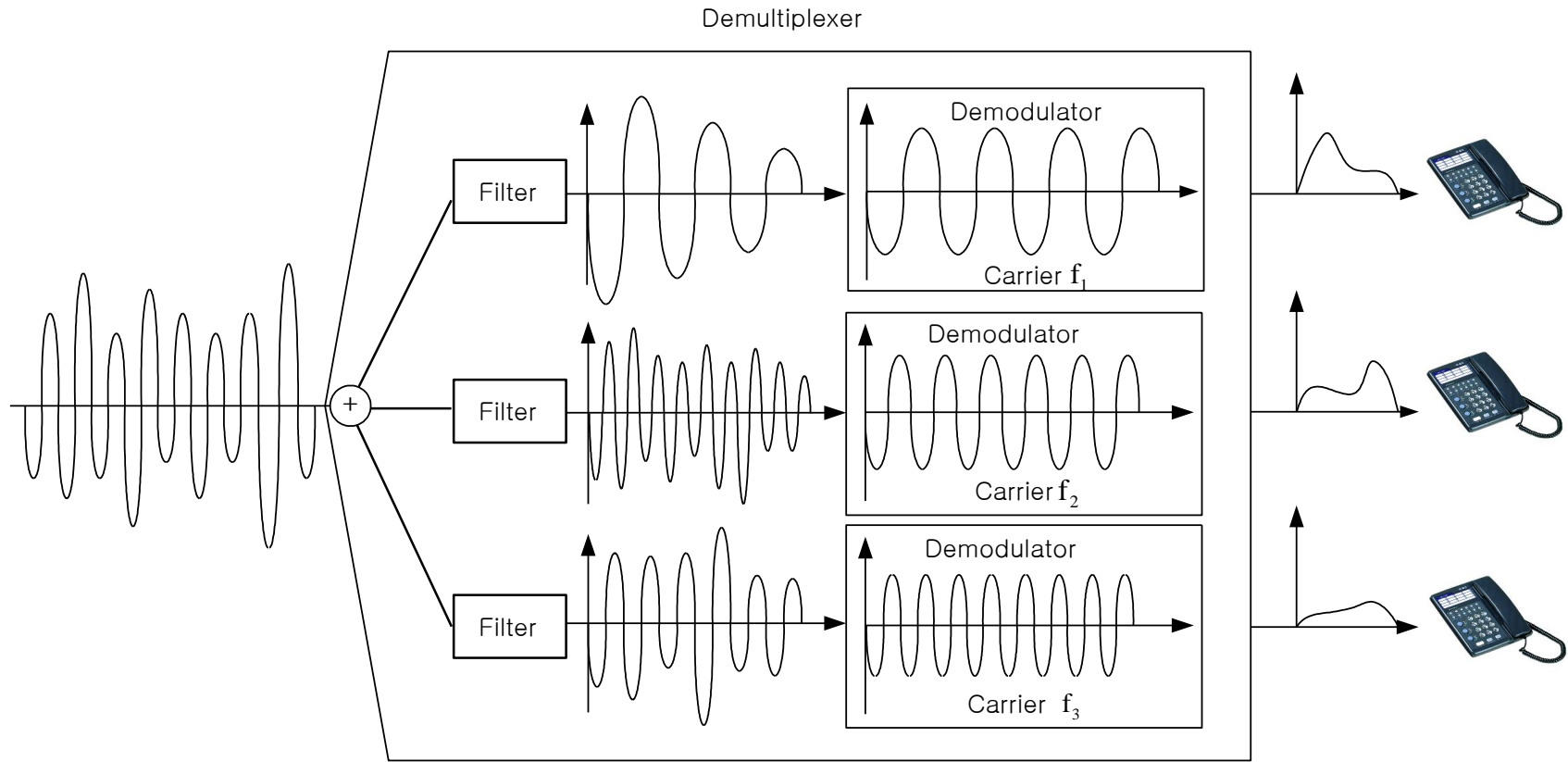

- FDM demultiplexing, frequency domain

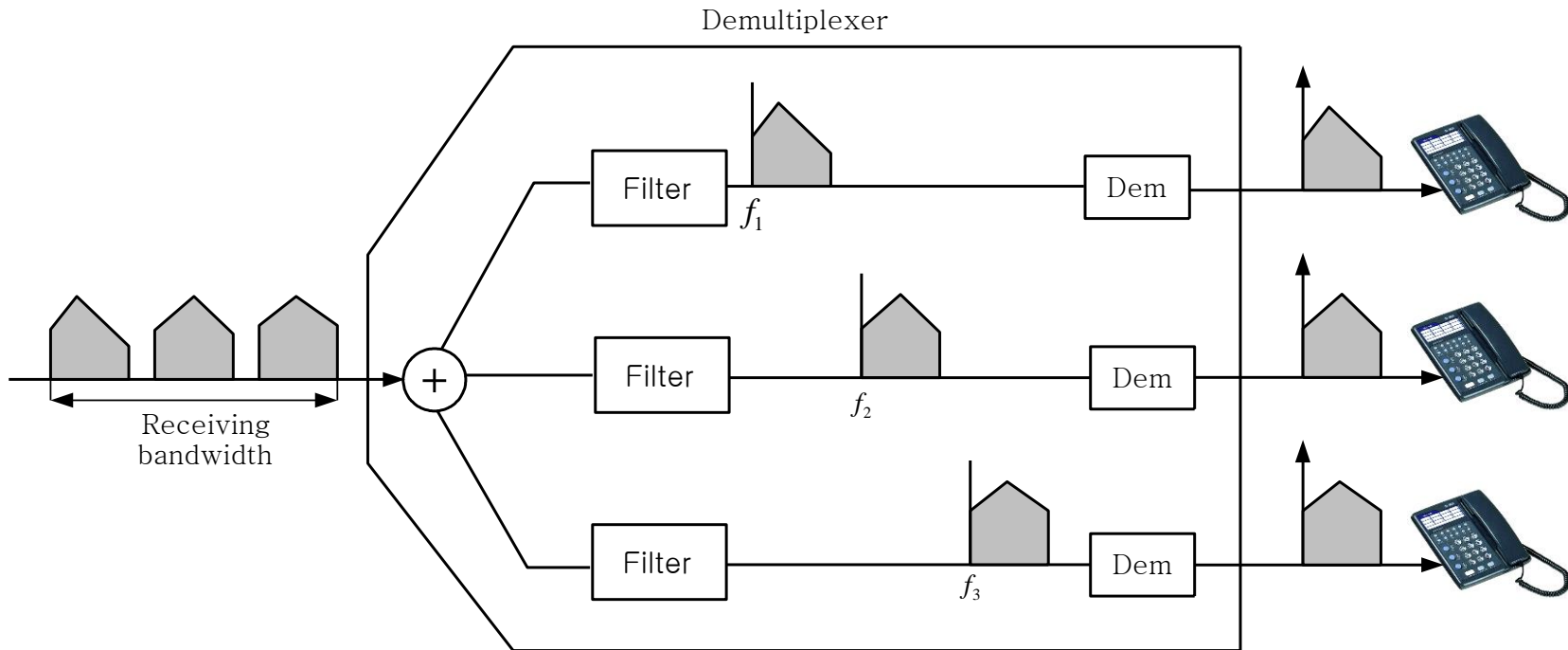

Multiplex

- + If two input signals(A and B) to a mixer are sinusoids
- + with the frequency of f_A and f_B
- +

$$\cos A \cos B = \frac{1}{2} [\cos(A + B) + \cos(A - B)]$$

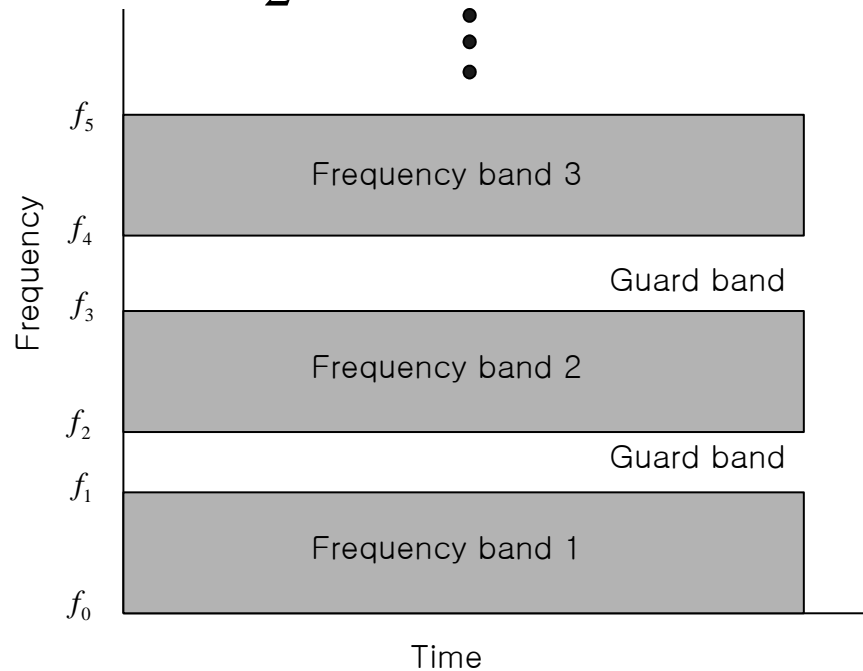

Frequency-division multiplexing

□ Synchronous TDM, multiplexing process

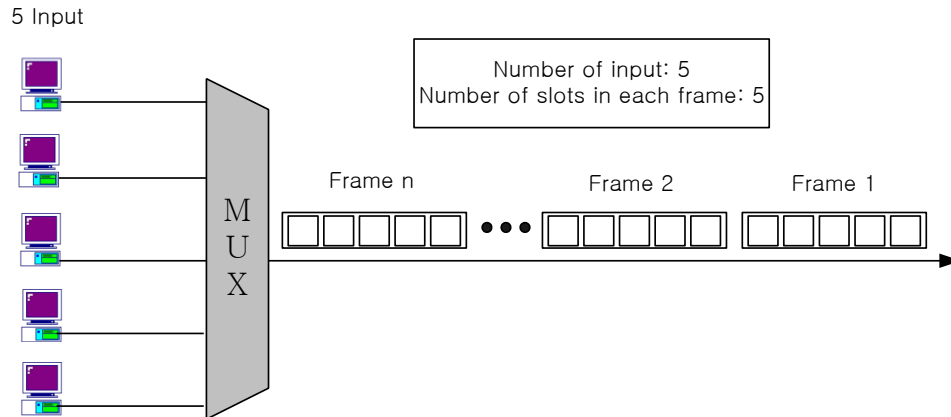

□ Synchronous TDM, demultiplexing process

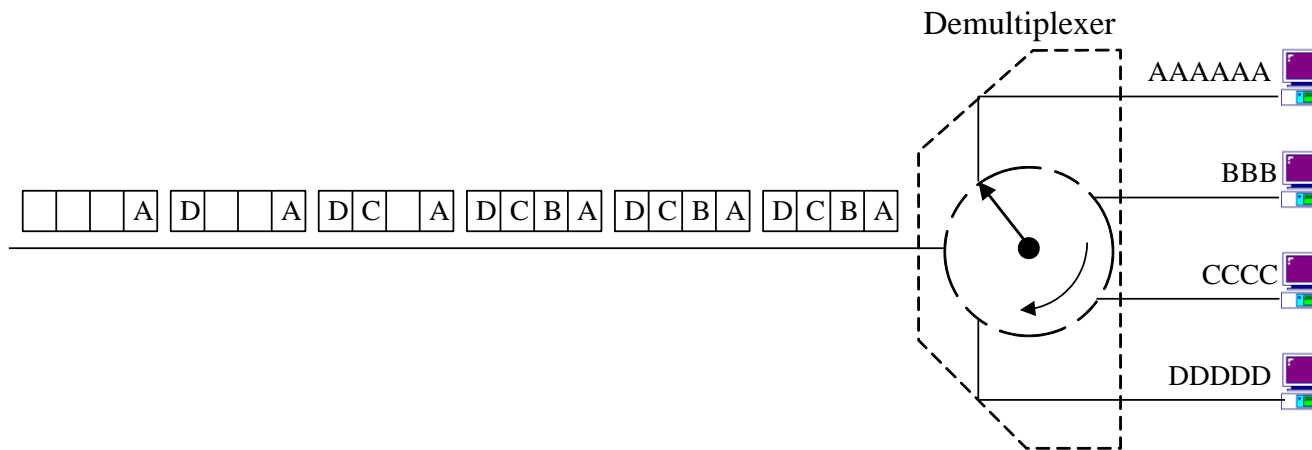

Digital Signal Processing

- T-1 line for multiplexing telephone lines

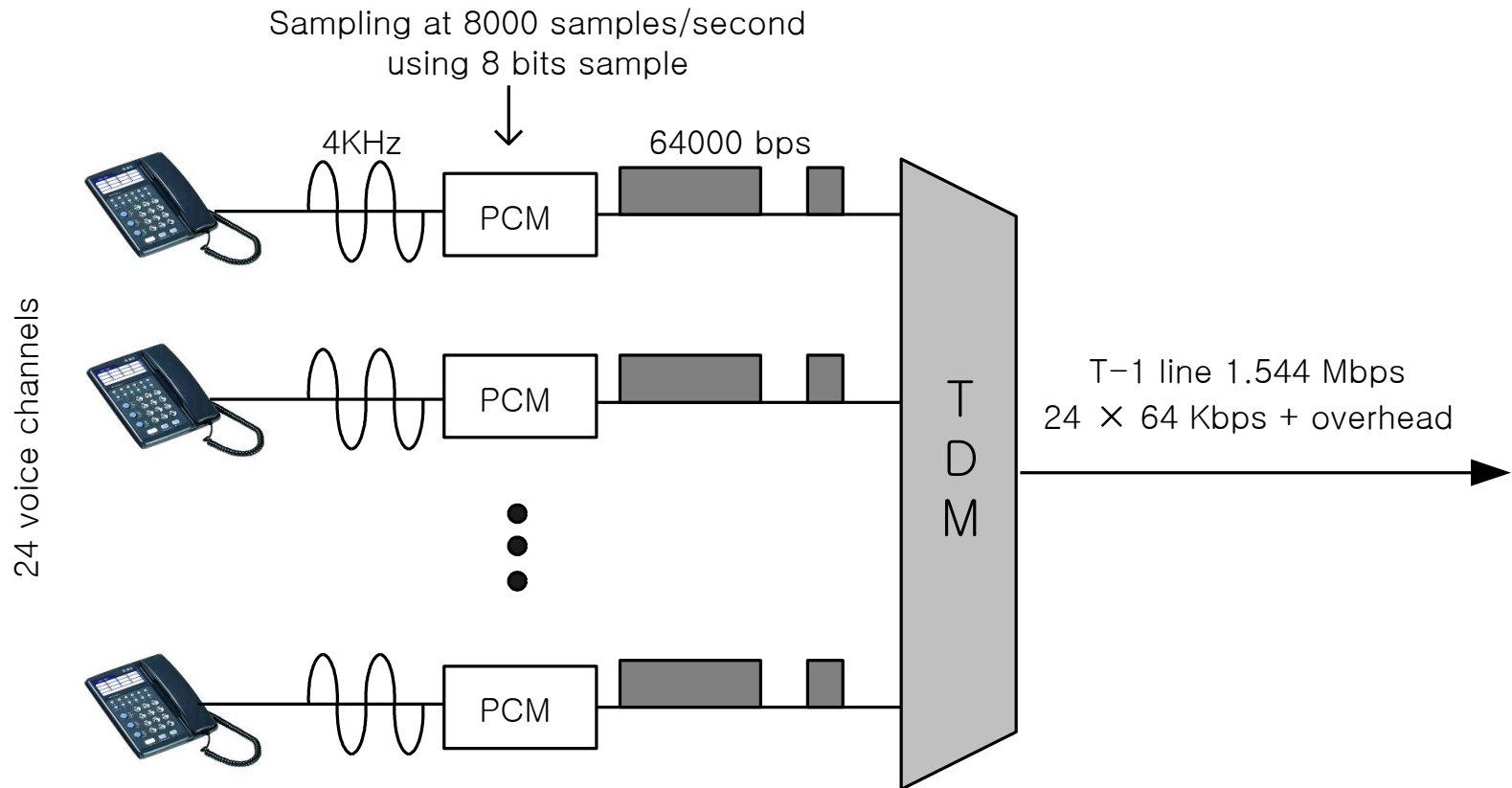

Digital Signal Processing

□ T-1 frame structure

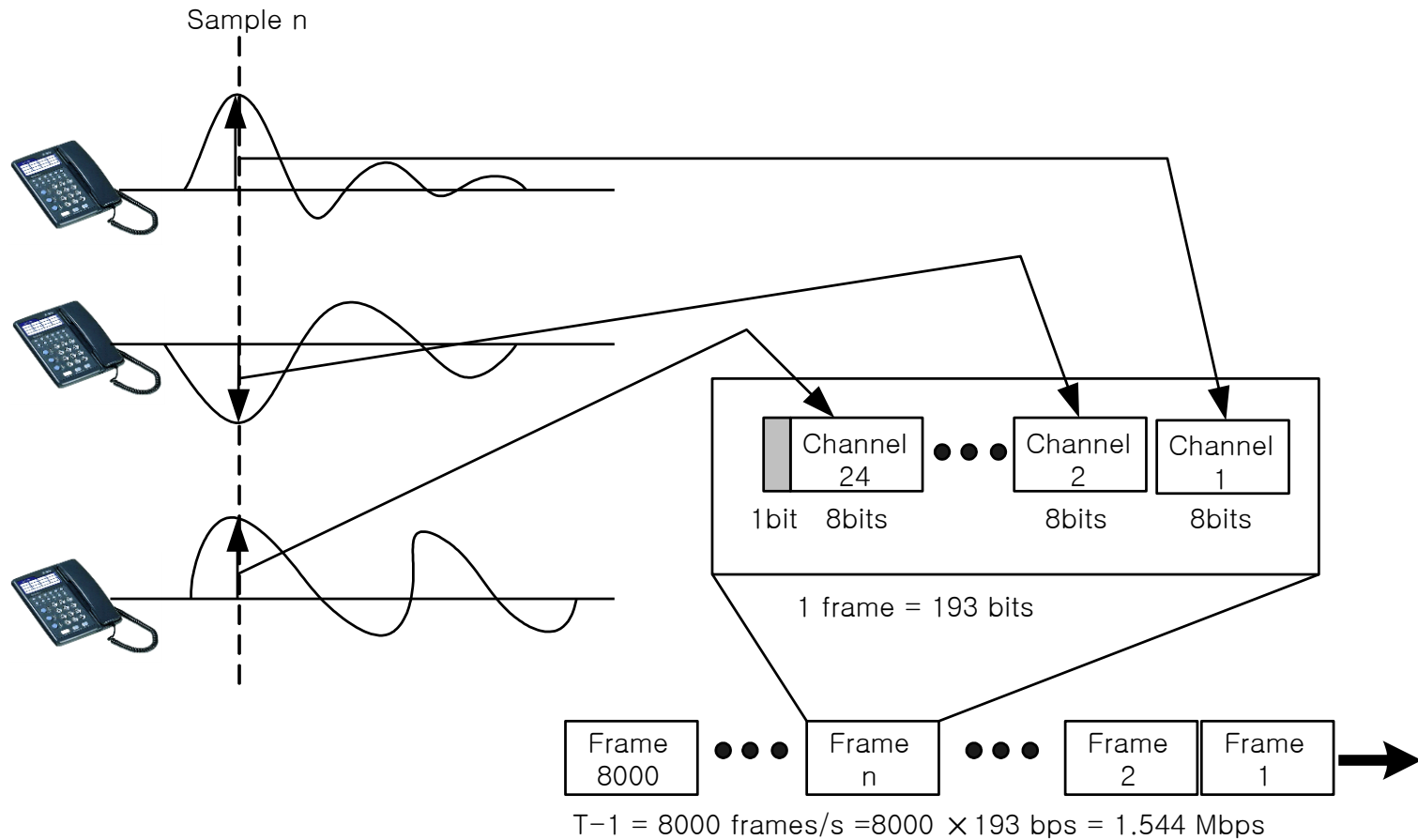

Multiplex

- + TDM : Time is segmented into intervals called frames.

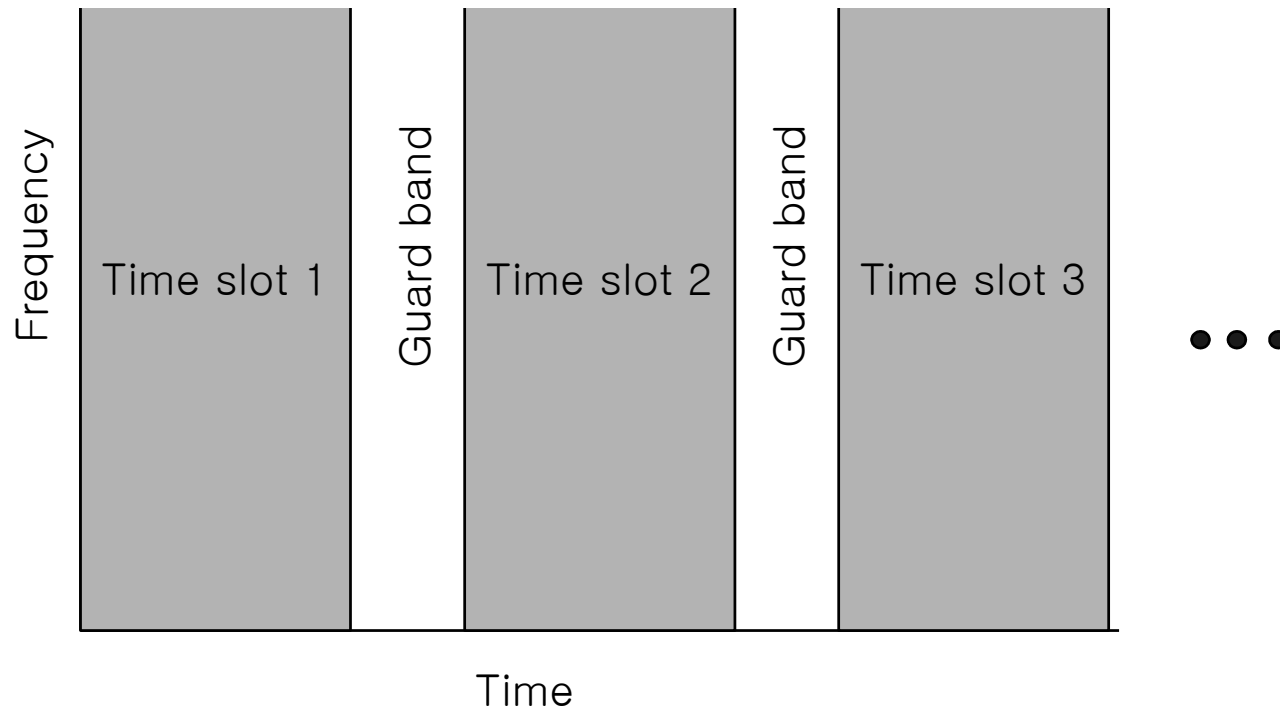

Time-division multiplexing

Multiplex

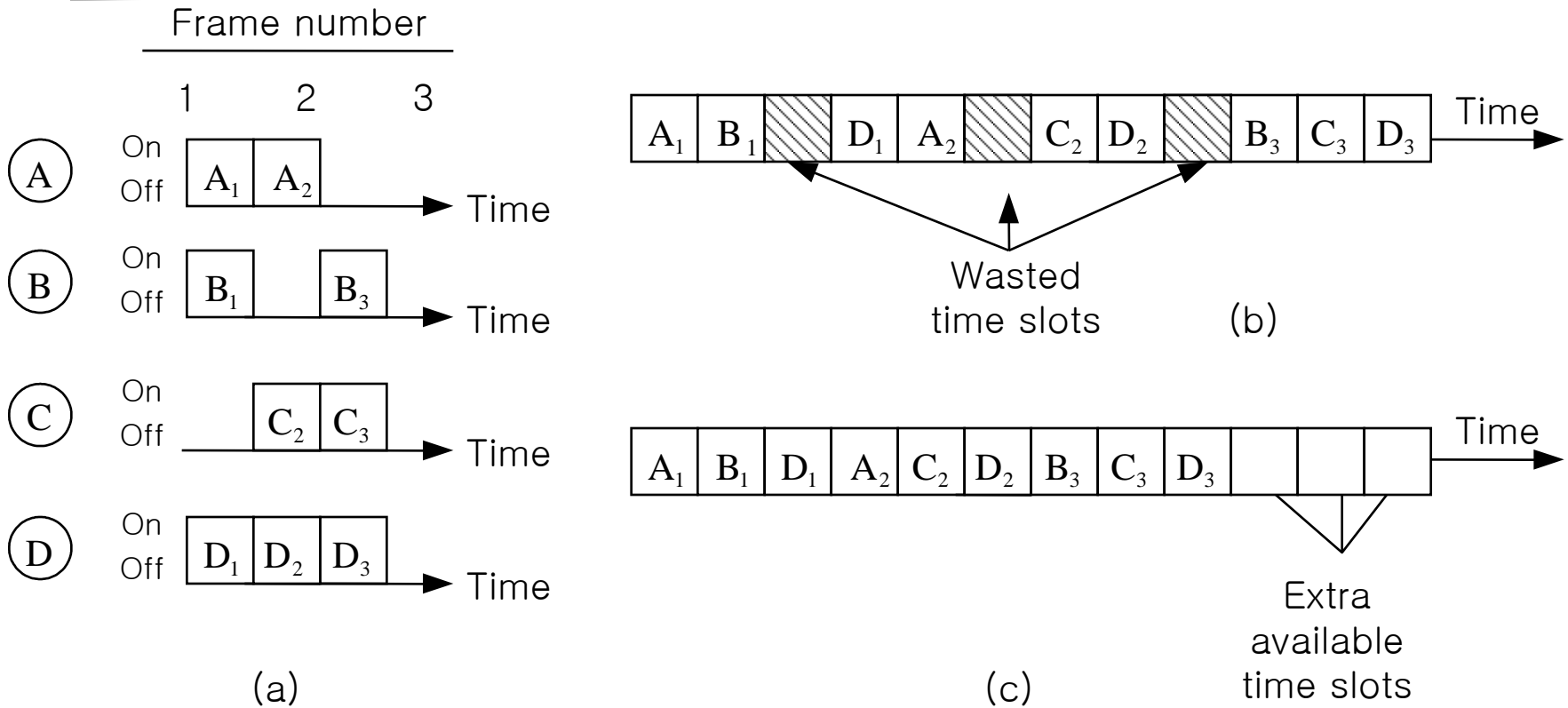

Fixed-assignment TDM versus packet switching. (a) Data source activity profiles. (b) Fixed-assignment time-assignment time-division multiplexing. (c) Time-division packet switching (concentration)

1. 파장분할 다중화(Wave(length) Division Multiplexing: WDM)

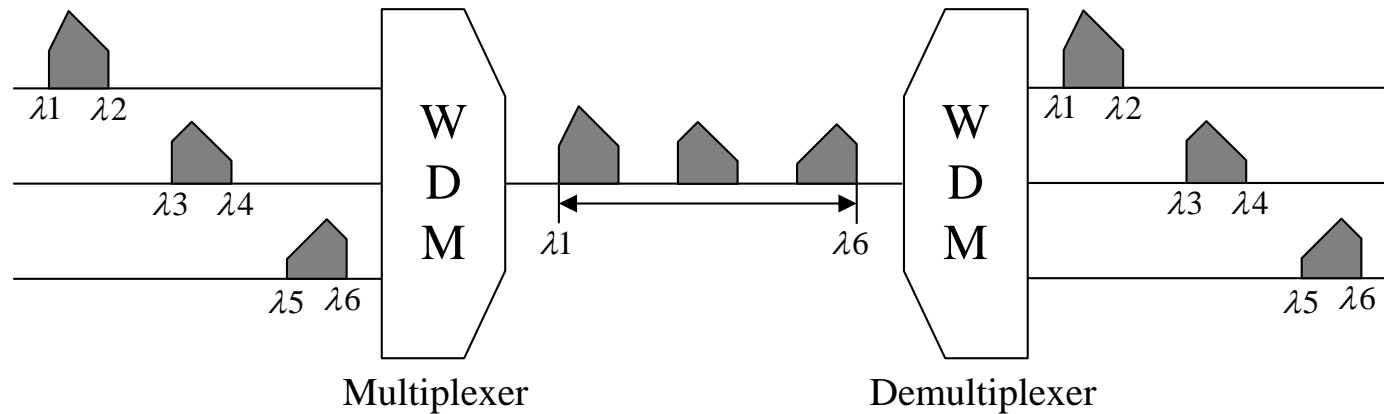

□ Prisms in WDM multiplexing and demultiplexing

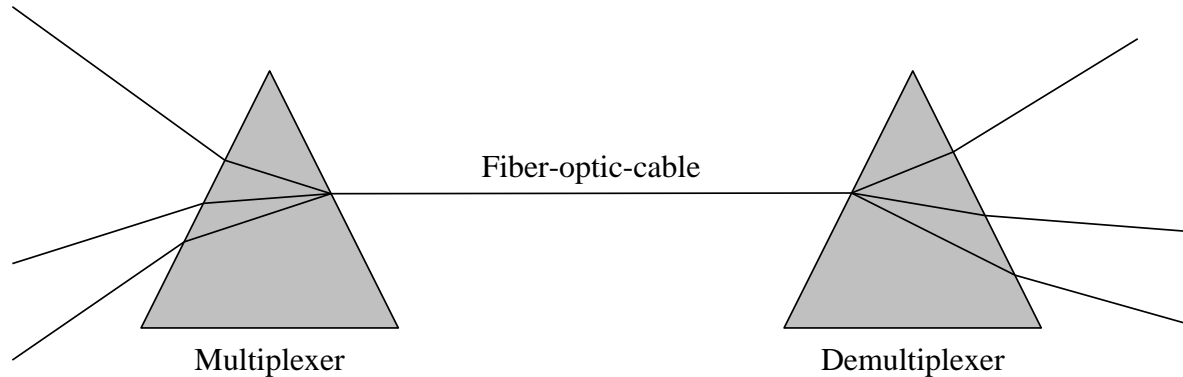

1. 주파수분할 다중접속(Frequency Division Multiple Access)

□ FDMA방식은 각 사용자가 주파수 대역으로 나누어 사용

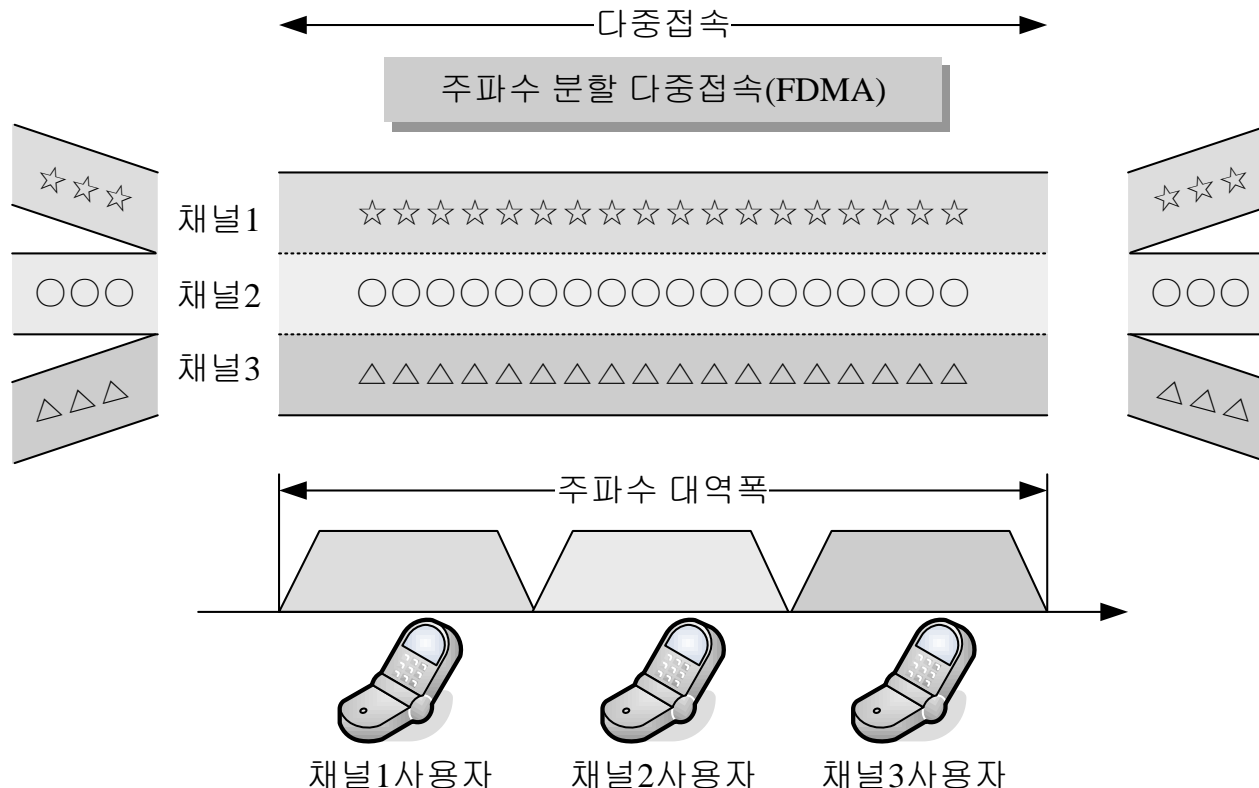

1. 주파수분할 다중접속(Frequency Division Multiple Access)

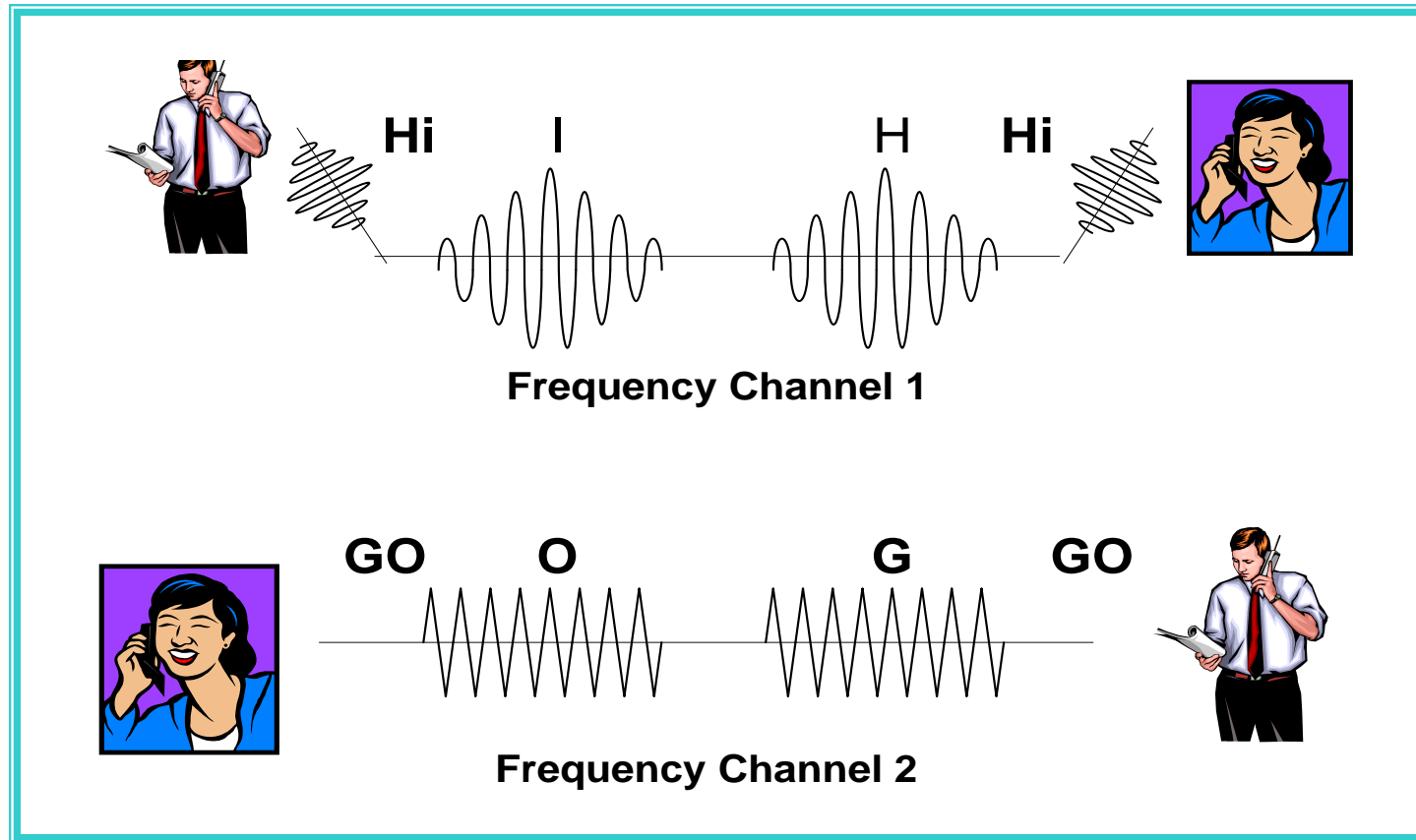

1. 시분할 다중접속(Time Division Multiple Access)

- 일정한 시간 간격으로 분할하여 각 사용자가 순서대로 할당된 시간 간격에 자신의 신호를 전송하는 방식

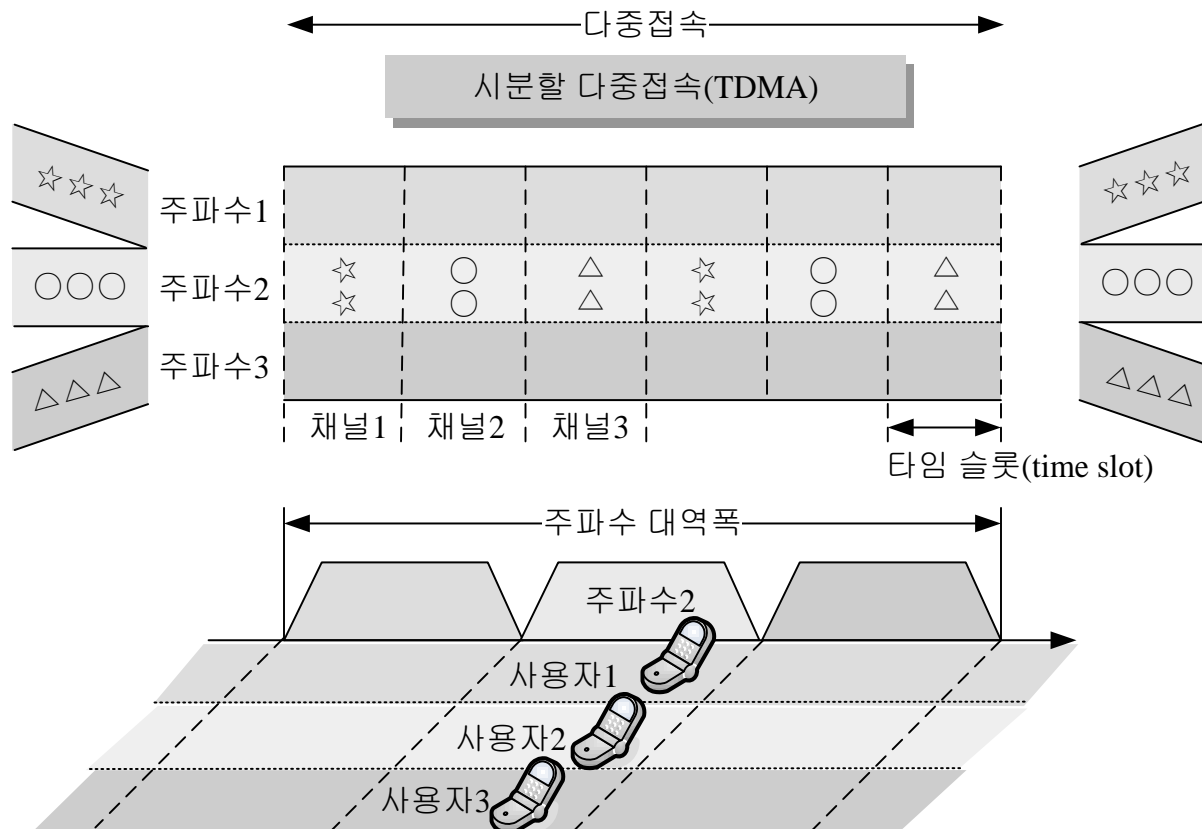

1. 시분할 다중접속(Time Division Multiple Access)

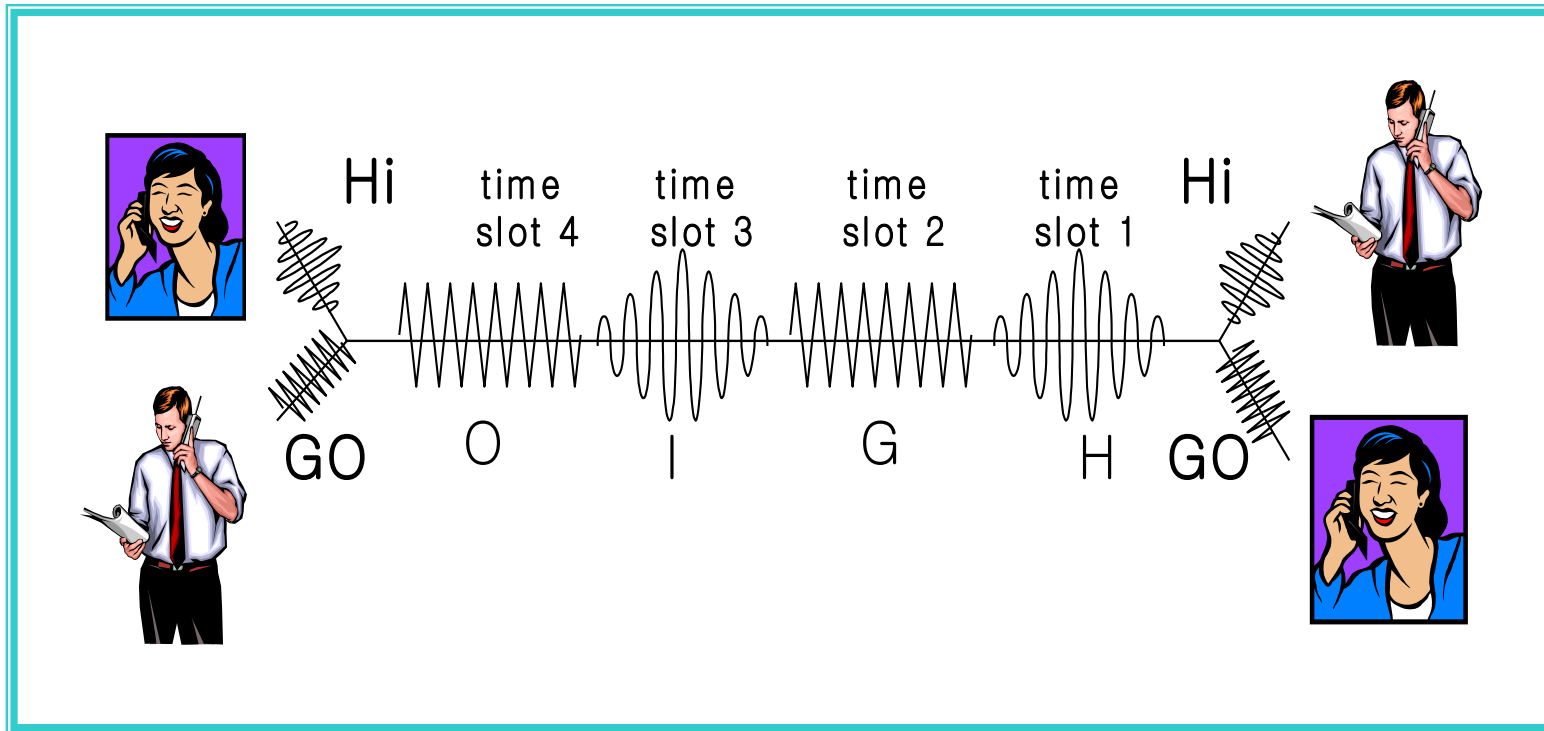

1. 코드분할 다중접속(Code Division Multiple Access)

- 여러 사용자가 동일한 주파수를 동시에 사용
- 송수신에서 동일한 코드를 사용하는 통화만을 선별적으로 골라내어 듣는 방식

부호분할 다중접속(CDMA)

☆☆☆	1010	☆ 1010 ○ 1001	1010	☆☆☆
○○○	1100	◇ 1100	1100	○○○
⋮	⋮	○ 1001 ◇ 1100	⋮	⋮
◇◇◇	1001	☆ 1010	1001	◇◇◇
		◇ 1100 ○ 1001		

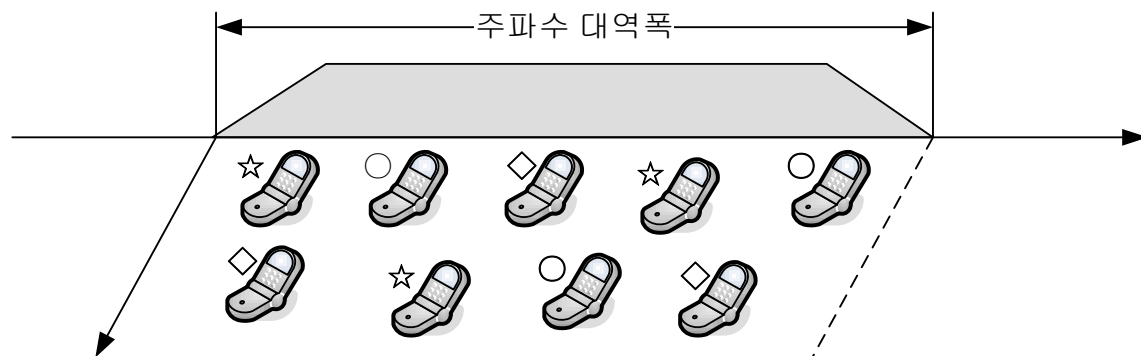

1. 코드분할 다중접속(Code Division Multiple Access)

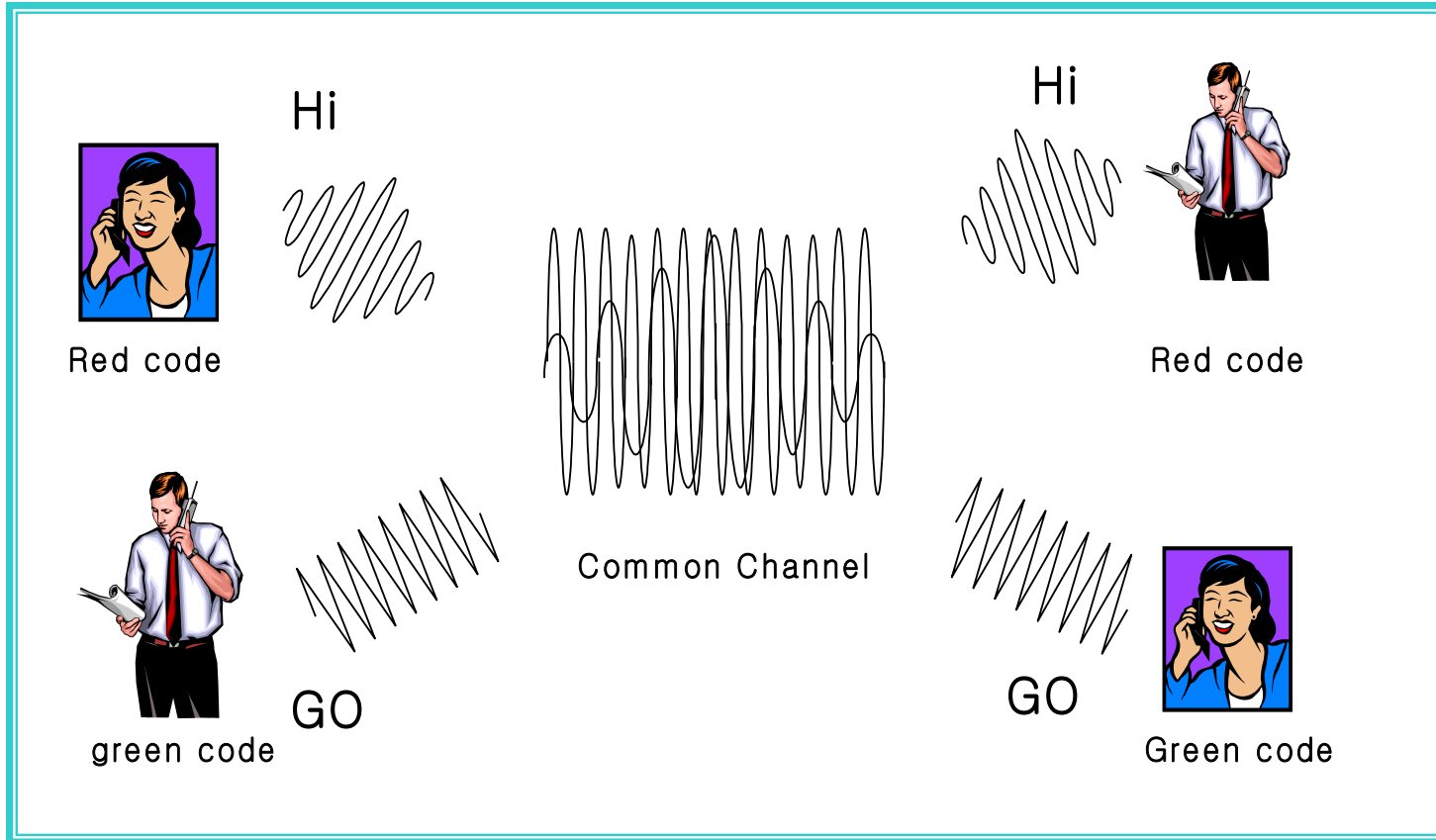

1. 코드분할 다중접속(CDMA)의 원리

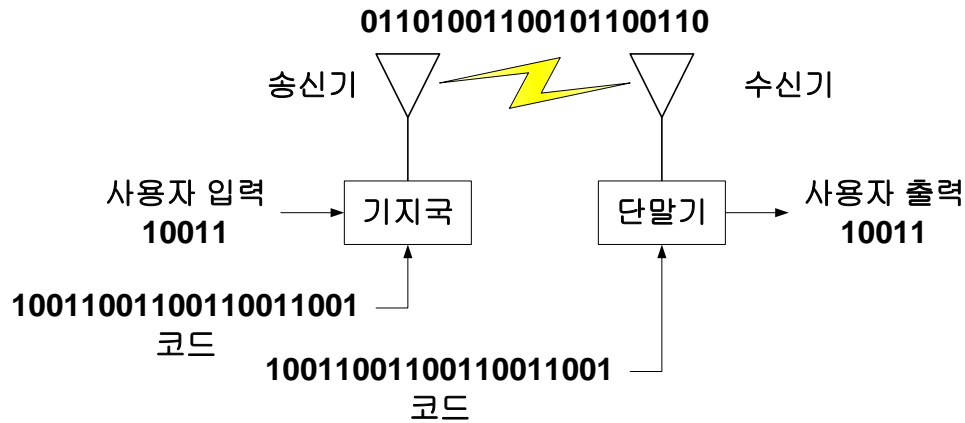

(a)

사용자 입력	1	0	0	1	1
확산 코드	1001	1001	1001	1001	1001
송신데이터	0110	1001	1001	0110	0110

(b)

수신데이터	0110	1001	1001	0110	0110
동일확산코드	1001	1001	1001	1001	1001
	1111	0000	0000	1111	1111
	1	0	0	1	1

(c)

수신데이터	0110	1001	1001	0110	0110
다른확산코드	0101	0101	0101	0101	0101
	0011	1100	1100	0011	0011
	?	?	?	?	?

(d)

RF System

1. 송신부(transmitter)와 수신부(receiver)로 구성

- 안테나(antenna)
- 증폭기(amplifier)
- 필터(filter)
- 믹서(mixer)
- 오실레이터(oscillator)

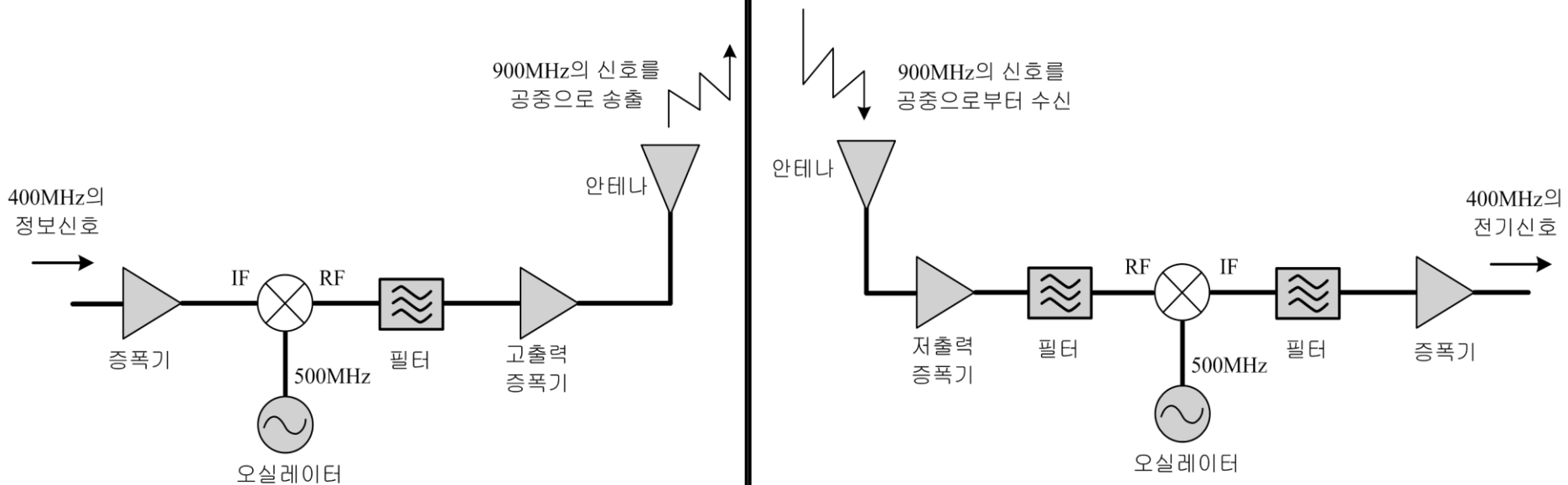



What Makes a Good Communication System?

1. Larger data transmission rate (measured in bits/sec)
2. Small bandwidth(measured in Hertz)
3. Small signal power(measured in Watts or dBW)
4. Low distortion(measured in S/N or bit error rate)
5. Low cost – with digital communications, large complexity does not always result in large cost
6. In practice, there must be trade-offs made in achieving these goals

Trade-offs in System Design : Data rate vs. Bandwidth

1. Increased data rate leads to shorter data pulses which leads to larger bandwidth
2. This trade-off can not be avoided – however, some system use bandwidth more efficiently than others

□ Using M-ary Modulation Tech.

참조 : 각 PSK 방식에 따른 대역폭 사용: [슬라이드 42](#)

3. Bandwidth efficiency,

$$\eta_B = R/W, \quad R : \text{Data Rate}, \quad W : \text{Transmission B.W.}$$

4. We want large bandwidth efficiency, η_B

Trade-offs in System Design : Fidelity vs. Signal Power

1. One way to get an error free signal would be to use huge amount of power to blast over the noise.
2. Some types of modulation achieve relative error free transmission at lower power than others.

-> Modulation 기법 비교

1. Energy efficiency, $\eta_E = E_b / N_0$
2. We desire small η_E



Trade-offs in System Design : Bandwidth efficiency vs. Energy efficiency

1. System design에서 대역폭과 에너지간의 Trade-off 필요
2. 예 :
 - Binary modulation sends only one bit per use of the channel. M-ary modulation can send multiple bits, but is more vulnerable to errors.
 - Error correction coding : inserting redundant bits improves bit error rate, but increases bandwidth.
3. This is a fundamental trade-off in digital communications